

24Ai™ 24Ao™ User Guide



MOTU

1280 Massachusetts Avenue
Cambridge, MA 02138
Business voice: (617) 576-2760
Business fax: (617) 576-3609
Web site: www.motu.com
Tech support: www.motu.com/support

SAFETY PRECAUTIONS AND ELECTRICAL REQUIREMENTS FOR THE 24Ai AND 24Ao ("PRODUCT")

 **CAUTION! READ THIS SAFETY GUIDE BEFORE YOU BEGIN INSTALLATION OR OPERATION. FAILURE TO COMPLY WITH SAFETY INSTRUCTIONS COULD RESULT IN BODILY INJURY OR EQUIPMENT DAMAGE.**

 **HAZARDOUS VOLAGES: CONTACT MAY CAUSE ELECTRIC SHOCK OR BURN. TURN OFF UNIT BEFORE SERVICING.**

WARNING: TO REDUCE THE RISK OF FIRE OR ELECTRICAL SHOCK, DO NOT EXPOSE THIS APPLIANCE TO RAIN OR OTHER MOISTURE.

CAUTION: TO REDUCE THE RISK OF ELECTRICAL SHOCK, DO NOT REMOVE COVER. NO USER-SERVICEABLE PARTS INSIDE. REFER SERVICING TO QUALIFIED SERVICE PERSONNEL.

WARNING: DO NOT PERMIT FINGERS TO TOUCH THE TERMINALS OF PLUGS WHEN INSTALLING OR REMOVING THE PLUG TO OR FROM THE OUTLET.

WARNING: IF NOT PROPERLY GROUNDED THE MOTU PRODUCT COULD CAUSE AN ELECTRICAL SHOCK.

The MOTU product is equipped with a three-conductor cord and grounding type plug which has a grounding prong, approved by Underwriters' Laboratories and the Canadian Standards Association. This plug requires a mating three-conductor grounded type outlet as shown in Figure A below. If the outlet you are planning to use for the MOTU product is of the two prong type, DO NOT REMOVE OR ALTER THE GROUNDING PRONG IN ANY MANNER. Use an adapter as shown below and always connect the grounding lug to a known ground. It is recommended that you have a qualified electrician replace the TWO prong outlet with a properly grounded THREE prong outlet. An adapter as illustrated below in Figure B is available for connecting plugs to two-prong receptacles.

Figure A

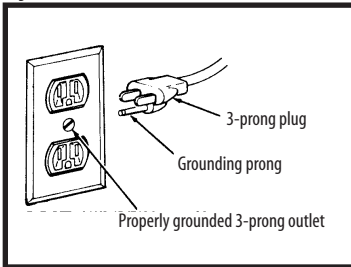
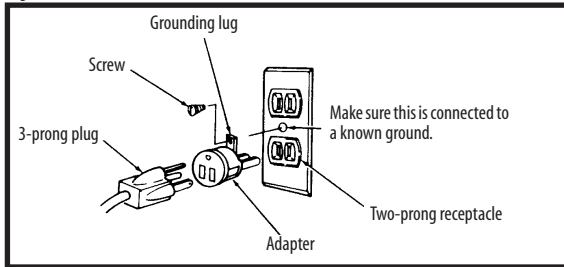

Figure B



WARNING: THE GREEN GROUNDING LUG EXTENDING FROM THE ADAPTER MUST BE CONNECTED TO A PERMANENT GROUND SUCH AS TO A PROPERLY GROUNDED OUTLET BOX. NOT ALL OUTLET BOXES ARE PROPERLY GROUNDED.

If you are not sure that your outlet box is properly grounded, have it checked by a qualified electrician. NOTE: The adapter illustrated is for use only if you already have a properly grounded two-prong receptacle. Adapter is not allowed in Canada by the Canadian Electrical Code. Use only three wire extension cords which have three-prong grounding type plugs and three-prong receptacles which will accept the MOTU product plug.

IMPORTANT SAFEGUARDS

1. Read these instructions. All the safety and operating instructions should be read before operating the product.
2. Keep these instructions. These safety instructions and the product owner's manual should be retained for future reference.
3. Heed all warnings. All warnings on the product and in the owner's manual should be adhered to.
4. Follow all instructions. All operating and use instructions should be followed.
5. Do not use the product near water.
6. Cleaning - Unplug the product from the computer and clean only with a dry cloth. Do not use liquid or aerosol cleaners.
7. Ventilation - Do not block any ventilation openings. Install in accordance with the manufacturer's instructions.
8. Heat - Do not install the product near any heat sources such as radiators, heat registers, stoves, or another apparatus (including an amplifier) that produces heat.
9. Overloading - Do not overload wall outlets and extension cords as this can result in a risk of fire or electrical shock.
10. Grounding - Do not defeat the safety purpose of the polarized or grounding-type plug. A polarized plug has two blades with one wider than the other. A grounding-type plug has two blades and a third grounding prong. The wide blade or the third prong are provided for your safety. If the provided plug does not fit into your outlet, consult an electrician for replacement of the obsolete outlet.
11. Power cord - Protect the product power cord from being walked on or pinched by items placed upon or against them. Pay particular attention to cords and plugs, convenience receptacles, and the point where they exit from the unit.
12. Power switch - Install the product so that the power switch can be accessed and operated at all times.
13. Disconnect - The main plug is considered to be the disconnect device for the product and shall remain readily operable.
14. Accessories - Only use attachments/accessories specified by the manufacturer.
15. Placement - Use only with the cart, stand, tripod, bracket or table specified by the manufacturer, or sold with the product. When a cart is used, use caution when moving the cart/apparatus combination to avoid injury from tip-over.
16. Surge protection - Unplug the product during lightning storms or when unused for long periods of time.
17. Servicing - Refer all servicing to qualified service personnel. Servicing is required when the product has been damaged in any way, such as when a power-supply cord or plug is damaged, liquid has been spilled or objects have fallen into the product, the product has been exposed to rain or moisture, does not operate normally, or has been dropped.
18. Power Sources - Refer to the manufacturer's operating instructions for power requirements. Be advised that different operating voltages may require the use of a different line cord and/or attachment plug.
19. Installation - Do not install the product in an unventilated rack, or directly above heat-producing equipment such as power amplifiers. Observe the maximum ambient operating temperature listed below.
20. Power amplifiers - Never attach audio power amplifier outputs directly to any of the unit's connectors.
21. Replacement Parts - When replacement parts are required, be sure the service technician has used replacement parts specified by the manufacturer or have the same characteristics as the original part. Unauthorized substitutions may result in fire, electric shock or other hazards.
22. Safety Check - Upon completion of any service or repairs to this MOTU product, ask the service technician to perform safety checks to determine that the product is in safe operating conditions.

ENVIRONMENT, HEAT AND VENTILATION

Operating Temperature: 10°C to 40°C (50°F to 104°F). The product should be situated away from heat sources or other equipment that produces heat. When installing the product in a rack or any other location, be sure there is adequate space around the product to ensure proper ventilation. Improper ventilation will cause overheating and can damage the unit.

TO REDUCE THE RISK OF ELECTRICAL SHOCK OR FIRE

Do not handle the power cord with wet hands. Do not pull on the power cord when disconnecting it from an AC wall outlet. Grasp it by the plug. Do not expose this apparatus to rain or moisture. Do not place objects containing liquids on it.

AC INPUT

100 - 240VAC ~ 50 / 60Hz • 0.5A max



CAUTION
RISK OF ELECTRIC SHOCK
DO NOT OPEN



Contents

Part 1: Getting Started

- 7 **Quick Start Guide**
- 9 **24Ai Front Panel**
- 10 **24Ai Rear Panel**
- 11 **24Ao Front Panel**
- 12 **24Ao Rear Panel**
- 13 **MOTU AVB Control Web App**
- 23 **About Your MOTU AVB Audio Interface**
- 27 **Packing List and System Requirements**
- 29 **Software Installation**
- 33 **Hardware Installation**

Part 2: Using your MOTU interface

- 47 **Presets**
- 53 **The Front Panel LCD**
- 55 **Working with Host Audio Software**
- 63 **Mixer Effects**
- 69 **Networking**

Part 3: Appendices

- 77 **Troubleshooting**
- 79 **Audio Specifications**
- 81 **Mixer Schematics**
- 85 **D-sub Connector Specifications**
- 87 **Updating Firmware**
- 89 **OSC Support**
- 91 **Index**

About the Mark of the Unicorn License Agreement and Limited Warranty on Software

TO PERSONS WHO PURCHASE OR USE THIS PRODUCT: carefully read all the terms and conditions of the "click-wrap" license agreement presented to you when you install the software. Using the software or this documentation indicates your acceptance of the terms and conditions of that license agreement.

Mark of the Unicorn, Inc. ("MOTU") owns both this program and its documentation. Both the program and the documentation are protected under applicable copyright, trademark, and trade-secret laws. Your right to use the program and the documentation are limited to the terms and conditions described in the license agreement.

Reminder of the terms of your license

This summary is not your license agreement, just a reminder of its terms. The actual license can be read and printed by running the installation program for the software. That license agreement is a contract, and clicking "Accept" binds you and MOTU to all its terms and conditions. In the event anything contained in this summary is incomplete or in conflict with the actual click-wrap license agreement, the terms of the click-wrap agreement prevail.

YOU MAY: (a) use the enclosed program on a single computer; (b) physically transfer the program from one computer to another provided that the program is used on only one computer at a time and that you remove any copies of the program from the computer from which the program is being transferred; (c) make copies of the program solely for backup purposes. You must reproduce and include the copyright notice on a label on any backup copy.

YOU MAY NOT: (a) distribute copies of the program or the documentation to others; (b) rent, lease or grant sublicenses or other rights to the program; (c) provide use of the program in a computer service business, network, time-sharing, multiple CPU or multiple user arrangement without the prior written consent of MOTU; (d) translate, adapt, reverse engineer, decompile, disassemble, or otherwise alter the program or related documentation without the prior written consent of MOTU.

MOTU warrants to the original licensee that the disk(s) on which the program is recorded be free from defects in materials and workmanship under normal use for a period of ninety (90) days from the date of purchase as evidenced by a copy of your receipt. If failure of the disk has resulted from accident, abuse or misapplication of the product, then MOTU shall have no responsibility to replace the disk(s) under this Limited Warranty.

THIS LIMITED WARRANTY AND RIGHT OF REPLACEMENT IS IN LIEU OF, AND YOU HEREBY WAIVE, ANY AND ALL OTHER WARRANTIES, BOTH EXPRESS AND IMPLIED, INCLUDING BUT NOT LIMITED TO WARRANTIES OF MERCHANTABILITY AND FITNESS FOR A PARTICULAR PURPOSE. THE LIABILITY OF MOTU PURSUANT TO THIS LIMITED WARRANTY SHALL BE LIMITED TO THE REPLACEMENT OF THE DEFECTIVE DISK(S), AND IN NO EVENT SHALL MOTU OR ITS SUPPLIERS, LICENSORS, OR AFFILIATES BE LIABLE FOR INCIDENTAL OR CONSEQUENTIAL DAMAGES, INCLUDING BUT NOT LIMITED TO LOSS OF USE, LOSS OF PROFITS, LOSS OF DATA OR DATA BEING RENDERED INACCURATE, OR LOSSES SUSTAINED BY THIRD PARTIES EVEN IF MOTU HAS BEEN ADVISED OF THE POSSIBILITY OF SUCH DAMAGES. THIS WARRANTY GIVES YOU SPECIFIC LEGAL RIGHTS WHICH MAY VARY FROM STATE TO STATE. SOME STATES DO NOT ALLOW THE LIMITATION OR EXCLUSION OF LIABILITY FOR CONSEQUENTIAL DAMAGES, SO THE ABOVE LIMITATION MAY NOT APPLY TO YOU.

Update Policy

In order to be eligible to obtain updates of the program, you must complete and return the attached Mark of the Unicorn Purchaser Registration Card to MOTU.

Copyright Notice

Copyright © 2015, 2014 by Mark of the Unicorn, Inc. All rights reserved. No part of this publication may be reproduced, transmitted, transcribed, stored in a retrieval system, or translated into any human or computer language, in any form or by any means whatsoever, without express written permission of Mark of the Unicorn, Inc., 1280 Massachusetts Avenue, Cambridge, MA, 02138, U.S.A.

Limited Warranty on Hardware

Mark of the Unicorn, Inc. and S&S Research ("MOTU/S&S") warrant this equipment against defects in materials and workmanship for a period of TWO (2) YEARS from the date of original retail purchase. This warranty applies only to hardware products; MOTU software is licensed and warranted pursuant to separate written statements.

If you discover a defect, first write or call Mark of the Unicorn at (617) 576-2760 to obtain a Return Merchandise Authorization Number. No service will be performed on any product returned without prior authorization. MOTU will, at its option, repair or replace the product at no charge to you, provided you return it during the warranty period, with transportation charges prepaid, to Mark of the Unicorn, Inc., 1280 Massachusetts Avenue, MA 02138. You must use the product's original packing material for in shipment, and insure the shipment for the value of the product. Please include your name, address, telephone number, a description of the problem, and the original, dated bill of sale with the returned unit and print the Return Merchandise Authorization Number on the outside of the box below the shipping address.

This warranty does not apply if the equipment has been damaged by accident, abuse, misuse, or misapplication; has been modified without the written permission of MOTU, or if the product serial number has been removed or defaced.

ALL IMPLIED WARRANTIES, INCLUDING IMPLIED WARRANTIES OF MERCHANTABILITY AND FITNESS FOR A PARTICULAR PURPOSE, ARE LIMITED IN DURATION TO TWO (2) YEARS FROM THE DATE OF THE ORIGINAL RETAIL PURCHASE OF THIS PRODUCT.

THE WARRANTY AND REMEDIES SET FORTH ABOVE ARE EXCLUSIVE AND IN LIEU OF ALL OTHERS, ORAL OR WRITTEN, EXPRESS OR IMPLIED. No MOTU/S&S dealer, agent, or employee is authorized to make any modification, extension, or addition to this warranty.

MOTU/S&S ARE NOT RESPONSIBLE FOR SPECIAL, INCIDENTAL, OR CONSEQUENTIAL DAMAGES RESULTING FROM ANY BREACH OF WARRANTY, OR UNDER ANY LEGAL THEORY, INCLUDING LOST PROFITS, DOWNTIME, GOODWILL, DAMAGE OR REPLACEMENT OF EQUIPMENT AND PROPERTY AND COST OF RECOVERING REPROGRAMMING, OR REPRODUCING ANY PROGRAM OR DATA STORED IN OR USED WITH MOTU/S&S PRODUCTS.

Some states do not allow the exclusion or limitation of implied warranties or liability for incidental or consequential damages, so the above limitation or exclusion may not apply to you. This warranty gives you specific legal rights, and you may have other rights which vary from state to state.

MOTU, Digital Performer, AudioDesk, Mark of the Unicorn and the unicorn silhouette logo are trademarks of Mark of the Unicorn, Inc.

Thunderbolt and the Thunderbolt logo are trademarks of Intel Corporation in the U.S. and/or other countries.

This equipment has been type tested and found to comply with the limits for a class B digital device, pursuant to Part 15 of the FCC Rules. These limits are designed to provide reasonable protection against harmful interference in a residential installation. This equipment generates, uses, and can radiate radio frequency energy and, if not installed and used in accordance with the instruction manual, may cause harmful interference to radio communications. However, there is no guarantee that interference will not occur in a particular installation. If this equipment does cause interference to radio or television equipment reception, which can be determined by turning the equipment off and on, the user is encouraged to try to correct the interference by any combination of the following measures:

- Relocate or reorient the receiving antenna
- Increase the separation between the equipment and the receiver
- Plug the equipment into an outlet on a circuit different from that to which the receiver is connected

If necessary, you can consult a dealer or experienced radio/television technician for additional assistance.

PLEASE NOTE: only equipment certified to comply with Class B (computer input/output devices, terminals, printers, etc.) should be attached to this equipment, and it must have shielded interface cables in order to comply with the Class B FCC limits on RF emissions.

WARNING: changes or modifications to this unit not expressly approved by the party responsible for compliance could void the user's authority to operate the equipment.



Part 1

Getting Started

Quick Start Guide

Thank you for purchasing a MOTU AVB interface! Follow these easy steps to get started quickly.

1 Download and run the *MOTU AVB Installer* or *MOTU AVB USB Installer.exe* found here:

<http://www.motu.com/avb>

2 (Optional) For access to your MOTU interface from your iPad or iPhone, download the MOTU AVB Discovery app from the Apple App Store.

 Your iPhone and iPad must be on the same WiFi network as your computer.

3 Connect your MOTU interface to your computer with a USB cable (included). If you have a Thunderbolt-equipped Mac running OS X Yosemite (10.10) or later, you can alternately connect your MOTU interface to the Mac's Ethernet port with a standard CAT-5e or CAT-6 Ethernet cable (sold separately).

4 Switch on your MOTU interface.

5 Open the *MOTU AVB Control* web app by doing one of the following:

- If you have a Mac, choose your MOTU interface from the MOTU AVB Discovery app menu.

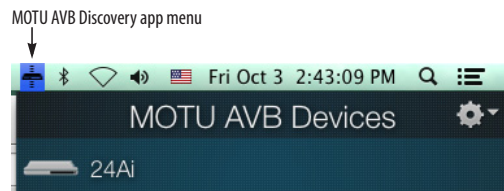

- If you have a PC, launch the *MOTU AVB WebUI Setup* shortcut found on the Windows desktop or in *Start menu > All Programs > MOTU*.

- From your iPad or iPhone, launch the MOTU AVB Discovery app, and tap your interface.

- You should now see the *MOTU AVB Control* web app in your browser, as shown on page 14. If not, visit Appendix A, “Troubleshooting” (page 77).

- For advanced network options, and device discovery from any modern browser, see chapter 9, “Networking” (page 69).

6 Choose a preset from the Quick Setup.

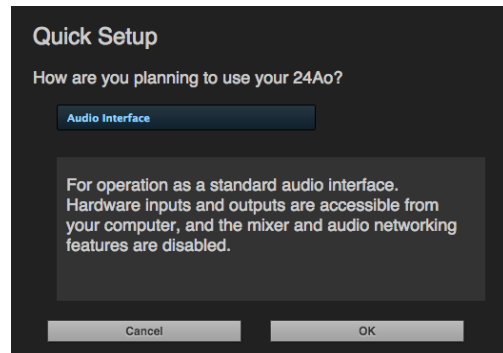

Preset	Application
Audio interface	Operate as a standard audio interface.
Stand-alone mixer	Operate as a stand-alone mixer, where all inputs are mixed to the main outs and monitor outs.
Interface + mixer	A combination of the above two presets.
Live recording with monitor mixing	Record a live concert or recording session, with a full monitor mix.
Stage I/O	Route audio inputs from one AVB interface to another, through Ethernet cabling.
Studio Input Expander	Routes the expansion unit's physical inputs to the main system using AVB network streams.
Studio Output Expander	Routes the main systems's AVB network streams to physical outputs on the expansion unit.
Optical Converter	Multi-channel analog-to-digital or digital-to-analog converter.

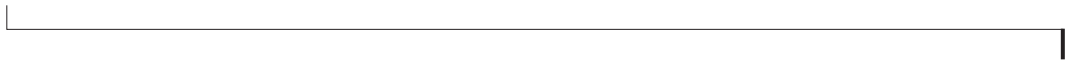

24Ai Front Panel



1. ANALOG INPUT METERS for the twenty-four analog inputs.
2. ADAT OPTICAL input and output metering. At 1x sample rates (44.1 or 48 kHz), there are twenty-four channels of input and output. At 2x (88.2 or 96 kHz), there are twelve channels.
3. The CLOCK section displays the current operating sample rate and clock mode (source) for the unit.
4. POWER SWITCH: AVB and USB are “plug-and-play” protocols. That means you can turn the 24Ai off and back on without restarting your computer.
5. Push SEL (select) to enter the LCD menu. Push the ARROW buttons to scroll through menu options. Push again to descend into the submenus, if applicable. To choose the current setting, push SELECT a third time. Push BACK to return to the previous menu level, and do so repeatedly to exit the menu altogether.
6. Push ID to display network settings for the device, including its IP address.

24Ai Rear Panel

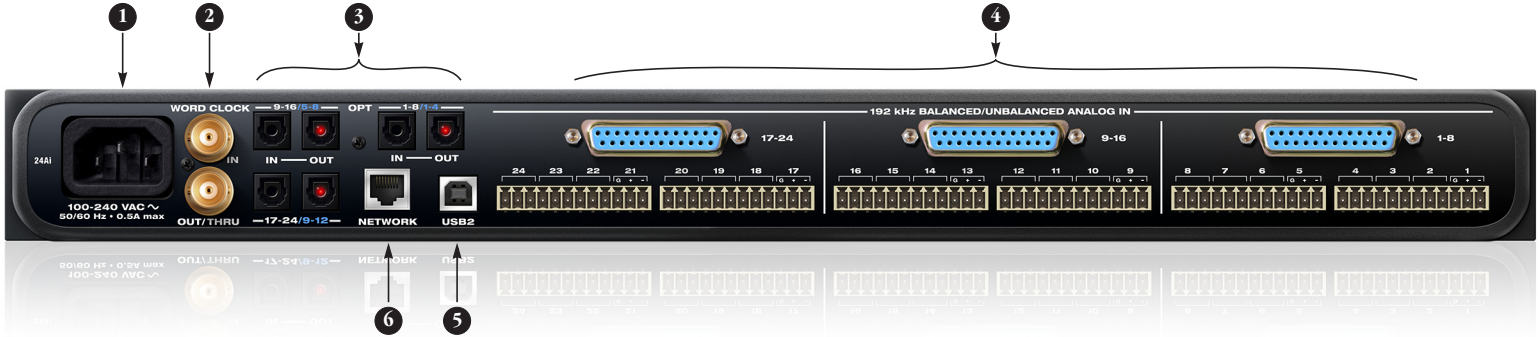
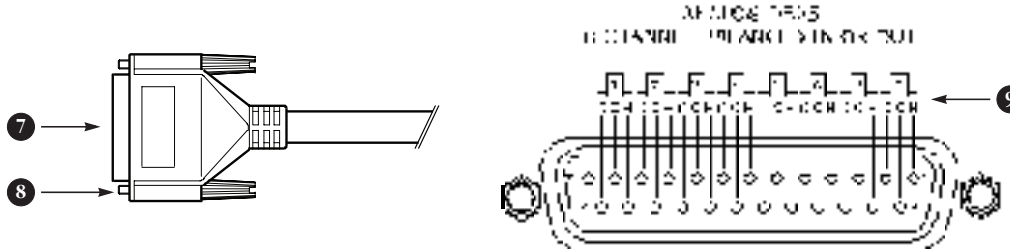

1. The 24Ai is equipped with an auto-switching international power supply.
2. BNC word clock jacks. Use them for a variety of applications, such as digital transfers with devices that cannot slave to the clock supplied by their digital I/O connection with the 24Ai.
3. These three ADAT optical "lightpipe" jacks provide 24 channels of 24-bit ADAT optical digital I/O at 1x sample rates (44.1 or 48 kHz) and 12 channels at 2x sample rates (88.2 or 96 kHz). They are disabled at higher sample rates. The IN and OUT ports on the right provide channels 1-8 (or 1-4), the left-hand ports provide channels 9-16 (or 5-8), and the third bank below provides channels 17-24 (or 9-12).
4. These three 8-channel banks provide 24 channels of balanced analog input. You can use either a standard 8-channel Panasonic/Tascam format DB-25 cable or the two 4-channel Phoenix connectors. **DO NOT** connect both the D-sub and Phoenix connectors for a bank at the same time. You can, however, use different connectors across banks, if needed (for example, D-sub for channels 1-8 and Phoenix for channels 9-16). The pin-outs for the Phoenix connectors are indicated on the label of the connector; for the D-sub pinouts, see Appendix D, "D-sub Connector Specifications" page (85).
5. Connect the 24Ai to the computer with this USB 2.0 port using a standard USB cable. You can connect it to a USB 2.0 or 3.0 port on the computer.
6. This AVB ethernet port provides industry standard IEEE 802.1 network connectivity to other network devices. Examples include:
 - Another 24Ai or any other MOTU AVB-equipped audio interface, such as the 1248, 8M, 16A, 24Ai, 24Ao, 112D, Monitor 8, etc.
 - A standard ethernet hub or Wi-Fi router (for internet connection and communication with the MOTU AVB Control web app software).
 - A standard AVB Ethernet switch for high-speed, low-latency, high-capacity audio connectivity to an AVB audio network.
 - A recent-generation Mac (any Mac with a Thunderbolt port) running OS X Yosemite (10.10) or later. This allows you to operate the 24Ai as an audio interface over Ethernet.
7. Use a standard (AES-59) Panasonic/Tascam DB-25 cable.
8. Make sure the retaining screws have standard 4-40 threading (not metric threading).
9. These are the pin-outs for the D-sub connector.

24Ao Front Panel



1. ANALOG OUTPUT METERS for the twenty-four analog outputs.
2. ADAT OPTICAL input and output metering. At 1x sample rates (44.1 or 48 kHz), there are twenty-four channels of input and output. At 2x (88.2 or 96 kHz), there are twelve channels.
3. The CLOCK section displays the current operating sample rate and clock mode (source) for the unit.
4. POWER SWITCH: AVB and USB are “plug-and-play” protocols. That means you can turn the 24Ao off and back on without restarting your computer.
5. Push SEL (select) to enter the LCD menu. Push the ARROW buttons to scroll through menu options. Push again to descend into the submenus, if applicable. To choose the current setting, push SELECT a third time. Push BACK to return to the previous menu level, and do so repeatedly to exit the menu altogether.
6. Push ID to display network settings for the device, including its IP address.

24Ao Rear Panel

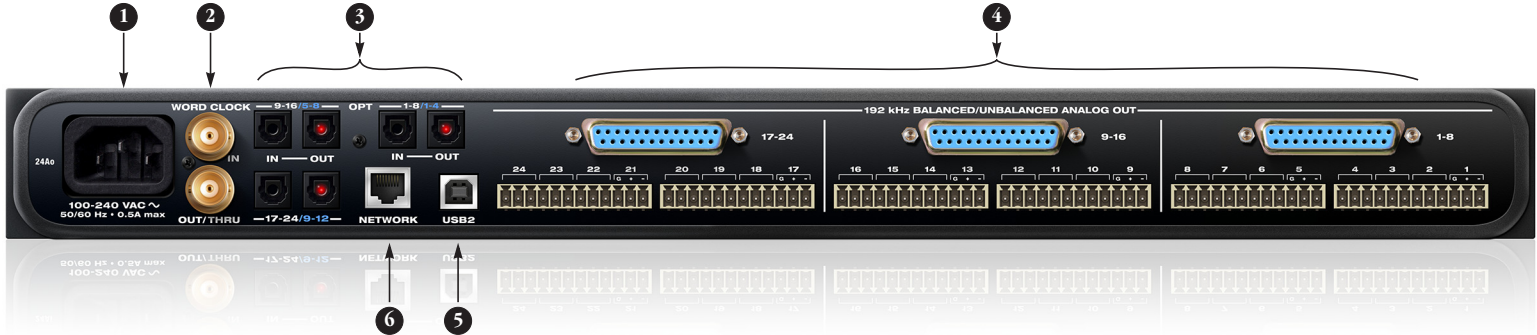
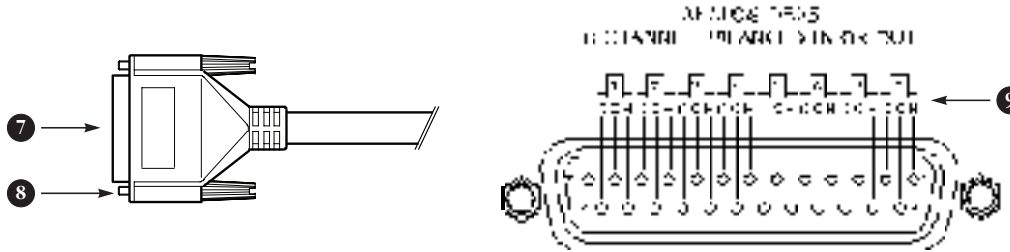

1. The 24Ao is equipped with an auto-switching international power supply.
2. BNC word clock jacks. Use them for a variety of applications, such as digital transfers with devices that cannot slave to the clock supplied by their digital I/O connection with the 24Ao.
3. These three ADAT optical "lightpipe" jacks provide 24 channels of 24-bit ADAT optical digital I/O at 1x sample rates (44.1 or 48 kHz) and 12 channels at 2x sample rates (88.2 or 96 kHz). They are disabled at higher sample rates. The IN and OUT ports on the right provide channels 1-8 (or 1-4), the left-hand ports provide channels 9-16 (or 5-8), and the third bank below provides channels 17-24 (or 9-12).
4. These three 8-channel banks provide 24 channels of balanced analog output. You can use either a standard 8-channel Panasonic/Tascam format DB-25 cable or the two 4-channel Phoenix connectors. DO NOT connect both the D-sub and Phoenix connectors for a bank at the same time. You can, however, use different connectors across banks, if needed (for example, D-sub for channels 1-8 and Phoenix for channels 9-16). The pin-outs for the Phoenix connectors are indicated on the label of the connector; for the D-sub pinouts, see Appendix D, "D-sub Connector Specifications" page (85).
5. Connect the 24Ao to the computer with this USB 2.0 port using a standard USB cable. You can connect it to a USB 2.0 or 3.0 port on the computer.
6. This AVB ethernet port provides industry standard IEEE 802.1 network connectivity to other network devices. Examples include:
 - Another 24Ao or any other MOTU AVB-equipped audio interface, such as the T248, 8M, 16A, 24Ai, 24Ao, 112D, Monitor 8, etc.
 - A standard ethernet hub or Wi-Fi router (for internet connection and communication with the MOTU AVB Control web app software).
 - A standard AVB Ethernet switch for high-speed, low-latency, high-capacity audio connectivity to an AVB audio network.
 - A recent-generation Mac (any Mac with a Thunderbolt port) running OS X Yosemite (10.10) or later. This allows you to operate the 24Ao as an audio interface over Ethernet.
7. Use a standard (AES-59) Panasonic/Tascam DB-25 cable.
8. Make sure the retaining screws have standard 4-40 threading (not metric threading).
9. These are the pin-outs for the D-sub connector.

MOTU AVB Control Web App

OVERVIEW

MOTU AVB Control is a web app that gives you complete control over your MOTU audio interface. If you have several MOTU AVB interfaces networked together, such as the 24Ai, 24Ao and 8M, you can control them all. If you are working with a large-scale network of many MOTU AVB interfaces, you can access and control any device on the network.

IT'S NOT ON YOUR HARD DRIVE

The MOTU AVB Control web app is served from the 24Ai and 24Ao hardware itself, therefore it is not an application on your computer's hard drive. Instead, access it by using the *MOTU AVB Discovery* app for Mac, the *MOTU AVB WebUI Setup* for Windows or through your browser by typing your MOTU device's IP Address.

USE YOUR FAVORITE WEB BROWSER

The MOTU AVB Control web app runs in any modern web browser on any device connected to your MOTU interface, either directly or wirelessly through a WiFi network. You can use any device you wish: a desktop computer, laptop, iPad, tablet, iPhone or smart phone. If it can run a web browser, it can run the web app. You can use any browser you prefer: Chrome, Firefox, Safari, IE 11 etc. The latest versions are strongly recommended.

CONTROL FROM MULTIPLE DEVICES

You can run the web app on multiple host devices simultaneously.

RUN THE INSTALLER, GET THE APP

Visit www.motu.com/avb to get the latest MOTU AVB installer and run it on your computer to install the *MOTU AVB Discovery* app (Mac) or *MOTU AVB WebUI Setup* (Windows) and other software elements. Visit the Apple App Store to download the discovery app onto your iPad or iPhone.

MAKE HARDWARE AND NETWORK CONNECTIONS

Connect your MOTU interface to your computer or laptop with a USB cable. Make sure your iPad, iPhone, tablet or smartphone is connected to the same WiFi network as your computer or device. You can use any network scenario explained in "Setup for web app control" on page 38.

LAUNCHING THE WEB APP

To launch the web app, do any of the following:

- If you have a Mac, choose the 24Ai or 24Ao from the MOTU AVB Discovery app menu, as shown below. If you are on Windows, launch the *MOTU AVB WebUI Setup* shortcut on the Windows desktop or in *Start menu > All Programs > MOTU*.

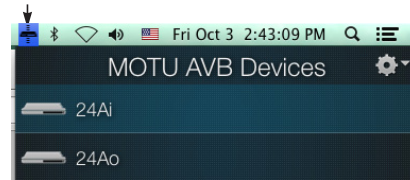

- From your iPad or iPhone, launch the MOTU AVB Discovery app.
- In your favorite web browser, type this URL: *localhost:1280*. (This URL requires a USB connection to the 24Ai or 24Ao.)
- If the 24Ai or 24Ao Ethernet port is connected to your Ethernet or Wi-Fi network, type the unit's IP address (see below) into your browser.

You should now see the MOTU AVB Control web app in your browser, as shown on page 14. If not visit Appendix A, "Troubleshooting" page (77).

Obtaining IP address for your 24Ai or 24Ao

On the front panel of the interface, push the ID button once. The LCD now displays the unit's IP address, which should look something like this: "IP Address: 192.168.1.209".

DEVICE TAB

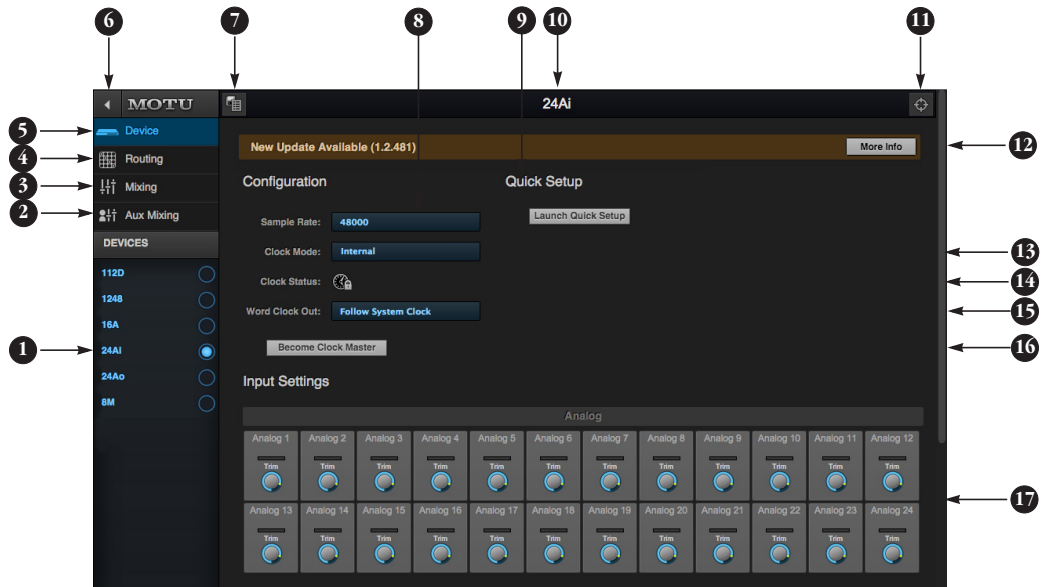

1. If you have two or more MOTU AVB interfaces, the Device list lets you choose the one you are currently controlling with the web app.
2. The Aux Mixing tab lets you view each Aux bus in the mixer, one at a time.
3. The Mixing tab gives you access to the mixing and DSP in the interface.
4. The Routing tab displays a grid matrix, where you can make direct connections between inputs and outputs, your computer, the mixer, and network audio streams, if networked interfaces are connected.
5. The Device tab has settings for the hardware itself, such as mic input phantom power and preamp gain.
6. Expands and collapses the sidebar.
7. Lets you create, save, recall and manage presets for your MOTU AVB interface. These presets capture and recall the complete state of the device (all settings in all tabs).
8. Choose the desired sample rate.
9. The Quick Setup button prompts factory presets used to configure your interface for a specific application. See chapter 5, "Presets" (page 47).
10. Click to rename the interface. To restore the default name, delete the current name.
11. Click this device ID button to identify the unit you are currently viewing and controlling with the web app software. The front panel LCD on the hardware itself will flash the name of the device, and its name will also flash in the Device list (1).
12. If an update is available for your device, and the computer you are viewing it from is connected to the internet, you'll be notified here. Click More Info to learn what's new and start the update process. Firmware updating requires a network connection. See Appendix E, "Updating Firmware" (page 87).
13. Choose the clock source from the Clock Mode menu. Your MOTU device will resolve its digital clock to this master source. See "Synchronization" on page 40.
14. Indicates that the current device (1) is successfully resolved to its chosen Clock Mode source (13). If it cannot lock for some reason, this icon flashes red. Check your chosen clock source, cables, etc.
15. At higher sample rates, the Word Clock Out can either follow the system clock or operate at the corresponding 1x sample rate. For details, see "Follow system clock / Force 1x clock" on page 42.
16. If you have multiple MOTU AVB interfaces, one of them may serve as a master clock source for the network. Click this button to choose the current interface (1) as the master clock source.
17. These are the Output Settings for the 24Ao, which provide 32 bit trim in the DACs from zero to -24 dB.
18. These are the Input Settings for the 24Ai, which provide digitally controlled analog trim from -96 to +22 dB.

DEVICE TAB (CONTINUED)

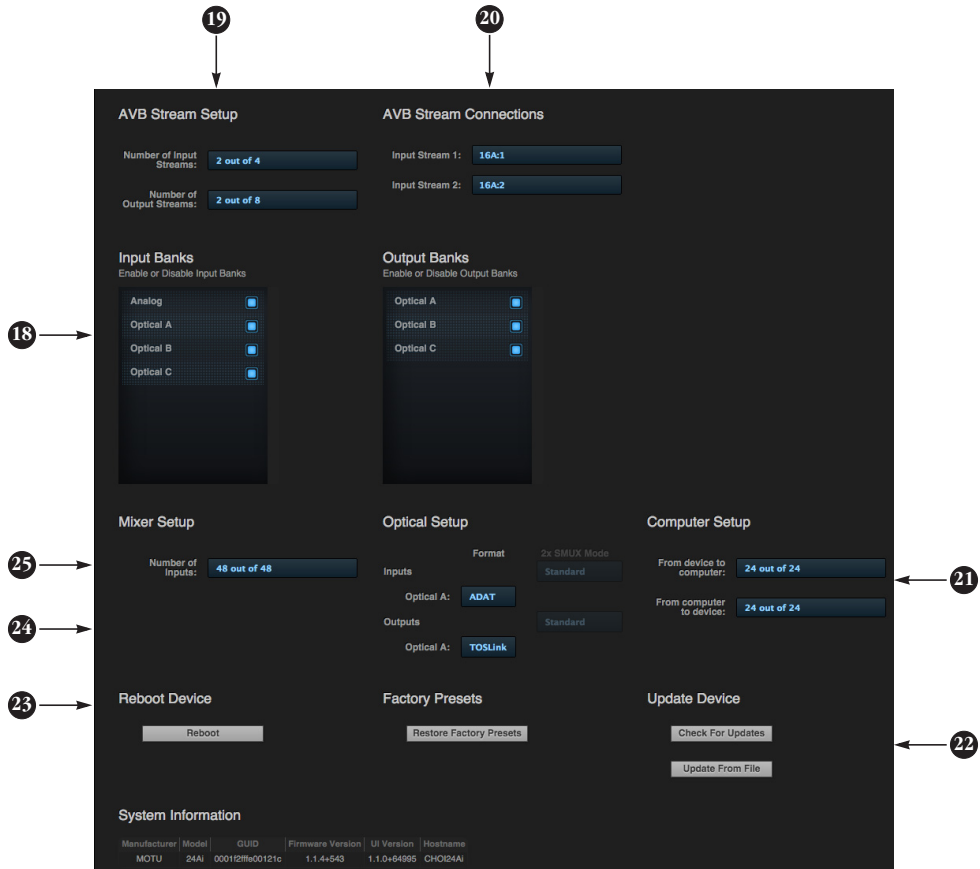

Scroll down to view these additional Device tab settings.

18. In the Input/Output Banks sections, you can disable any banks that you are not using. Doing so hides them from the routing matrix and mixer to simplify operation. Doing so also helps conserve DSP resources.

19. AVB is IEEE's Audio Video Bridging Ethernet standard for high-bandwidth, low-latency audio streaming over Ethernet. If your 24Ai or 24Ao is connected to a 2nd MOTU AVB interface through its network port, or to an AVB switch for access to an extended AVB network, you can stream audio channels to

other destinations on the network. AVB streams are handled in banks of eight channels, so if you enable 8 out of 8 streams, that's 64 channels. See chapter 9, "Networking" (page 69).

20. If you have AVB network input streams enabled, connect them to the output streams of other devices on the network here.

21. In the Computer Setup section, you can specify how many audio channels you would like to be able to stream to and from your computer, up to 24 channels each way, simultaneously. Map them as desired in the Routing tab (page 16).

22. Use these buttons to manually check for and install updates for your MOTU AVB device. For complete details, see Appendix E, "Updating Firmware" page (87). Updating from a file can be done offline from your computer, using an update you've obtained through MOTU's web site or tech support department. The *Check For Updates* button requires that the computer (or device) you are using to view your MOTU AVB interface is connected to the internet through a local network or WiFi. Updating from the internet is easy and convenient.

23. Use these buttons to reboot (restart) the device, or restore its factory presets.

24. In the Optical Setup section, you can choose between 8-channel ADAT or stereo TOSLink formats for bank A input and output, independently. At 882. or 96 kHz, the ADAT setting supports 4-channel SMUX format. For details, see "Optical" on page 40.

25. The digital mixer in your MOTU AVB interface supports up to 48 channels. If you don't need that many inputs, you can lower the number here to simplify mixer and routing operation and conserve DSP bandwidth for effects processing.

ROUTING TAB

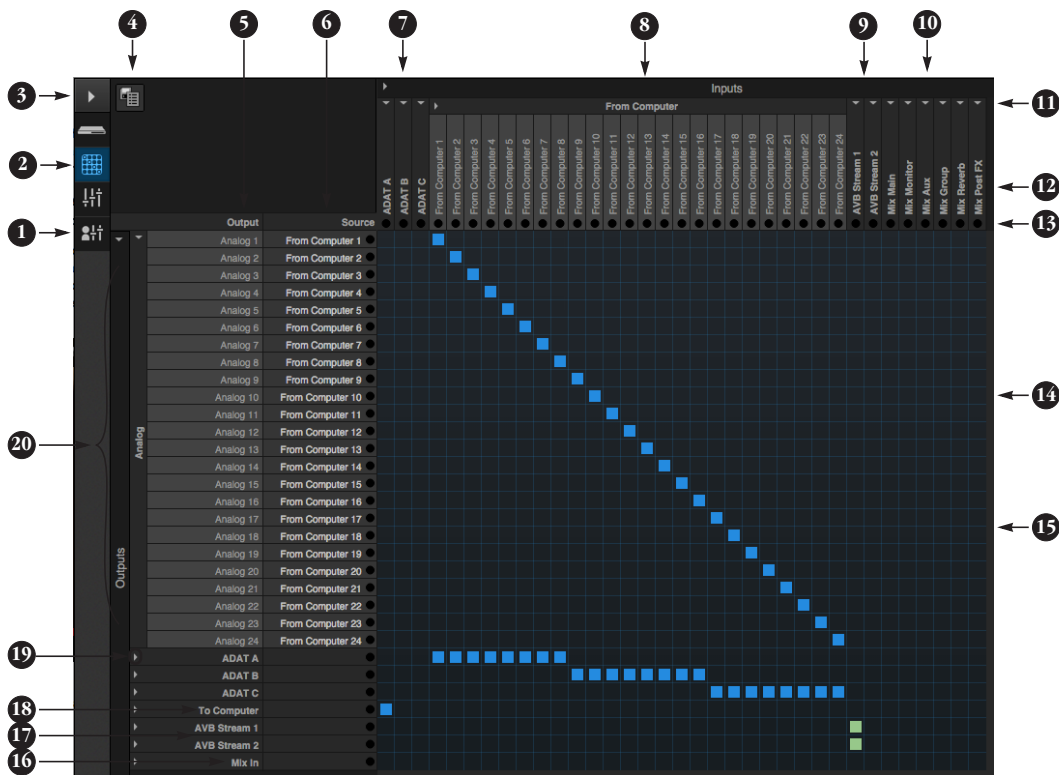

The Routing Tab lets you route inputs to outputs. Outputs are listed by row on the left; inputs are listed in columns across the top. Simply click in the grid to make a single connection. Click and drag to make multiple connections in one gesture. To route a single input to multiple outputs, make multiple connections vertically in the same column below the input. To mix multiple inputs to the same output, you'll need to use the mixer (page 17) and the *Mix In* bank in the routing tab (16).

1. In its collapsed form, (shown here), the sidebar displays icons for each tab.
2. Click this icon to view the Routing tab, shown on this page.
3. Click here to show or hide the sidebar.
4. Create, save, recall and manage routing presets.
5. Outputs are listed in rows on the left.

6. When you make a connection, the source (input) signal is listed by name here in the Source column, just to the right of the output it is being routed to.
7. Inputs are listed in columns across the top of the grid, starting with the physical inputs on the hardware itself. In this example, each 8-channel ADAT optical bank is collapsed. In the grid below, in the first column, you can see that Bank A input is routed to the computer.
8. The *From Computer* input bank lets you route audio channels from your host audio software to any output, including AVB network streams or the mixer. In this example, all 24 computer output channels are routed to the 24Ao analog outs. Use the Device tab to choose how many computer channels are available.
9. AVB streams are 8-channel banks that let you route audio to or from other devices on the AVB network (if any are connected) to local hardware inputs and outputs. Use

the Device tab (page 15) to configure how many AVB streams you wish to work with. If you aren't working with network audio, you can set the number of streams to zero.

10. These input streams are busses that originate from the mixer, which supplies the main mix bus, monitor mix bus, seven stereo aux busses, three stereo group busses, a reverb return bus and postFX channel sends (for sending processed inputs to the computer or elsewhere). You can route these mixer busses to any outputs you wish (5), including physical outputs, host software on your computer, other devices on the AVB network, or even back in to the mixer (beware of feedback loops!)
11. Use these triangles to expand or collapse groups of inputs. For example, it might be convenient to collapse banks that you are not using at the moment.
12. Click a channel label to rename it.
13. Audio activity indicators.

14. Click the grid to make a connection. Click a connection to remove it. Click and drag to make or break multiple connections in one gesture.
15. In this example, all 24 channels from the computer are routed to the 24 analog outputs on the 24Ao. In addition, all 24 computer channels are simultaneously being routed to the three ADAT banks, for 24 channels of digital output.
16. The *Mix In* group lets you route audio to the 48-channel mixer.
17. These AVB output streams let you route any audio to other devices on the AVB network.
18. The *To Computer* output bank routes any input to host audio software running on your computer. Use the Device tab to choose how many computer channels are available.
19. Use these triangles to expand or collapse groups of outputs.
20. These are the physical outputs on the interface itself.

MIXING TAB

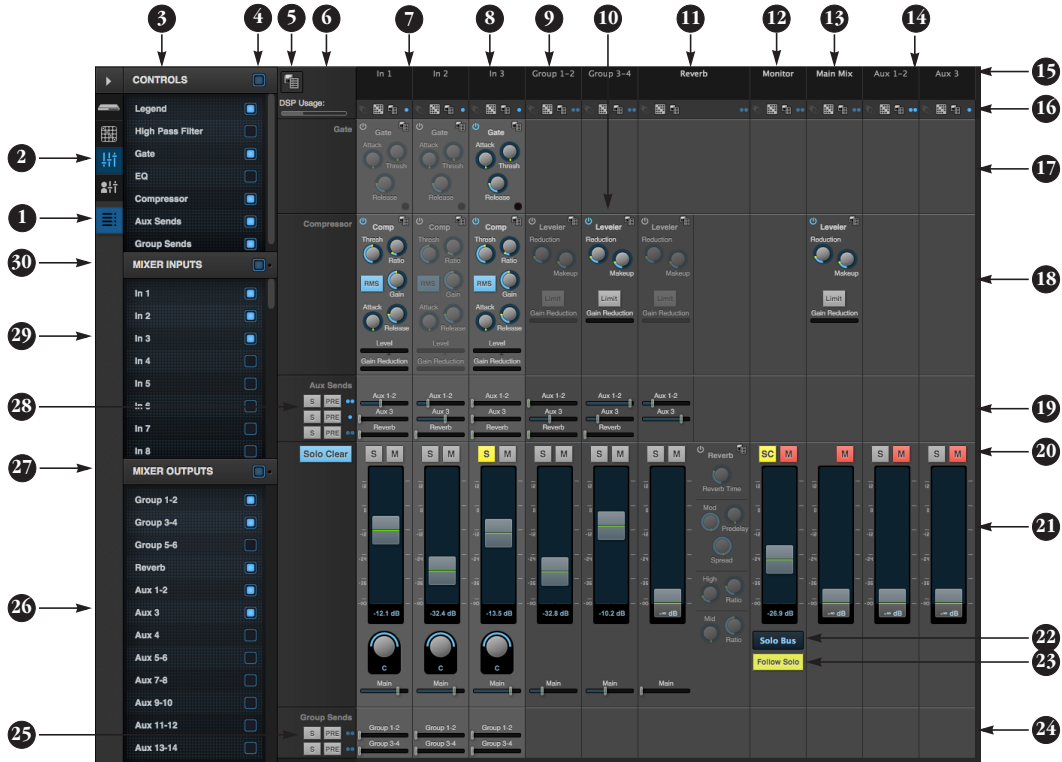

The Mixing tab gives you full access to the 48-channel mixer in your MOTU AVB interface, which provides a main mix bus, monitor bus, three group busses, seven aux busses, and a dedicated reverb bus. Use the Device tab to configure how many inputs you wish to work with (up to 48). Use the Routing tab (page 16) to route channels to the mixer inputs. Channels can come from any source, such as the physical inputs on the interface, channels coming from the computer, or channels coming from the AVB network.

1. Shows and hides the Mixer Setup sidebar (3), which lets you show and hide channels, channel strip settings, effects, and the Legend (6).
2. The Mixing tab selects the mixer.
3. Use the Mixer Setup sidebar to show and hide elements in the mixer.
4. Shows and hides all elements in the section with one click.
5. Create, save, recall and manage mixer presets.

6. This column is the Legend. It provides labels and controls for channel strip sections. The menu at the top lets you create, name, save and manage entire mixer presets.
7. Mixer input channels.
8. This input channel has its Gate and Compressor enabled. Disabled effects are grayed out.
9. This is Group bus 1-2. You can send inputs to this group with their Group send fader (24) or aux busses (19).
10. Group buses, the main mix bus, and the reverb return bus are equipped with the Leveler, a vintage compressor modeled after the Teletronix LA-2A leveling amplifier.
11. The reverb channel strip provides controls for the reverb processor. Use the reverb send on individual inputs or groups to route them to the reverb bus, which can then be mixed

in with the main mix or aux busses. Disable the reverb processor to use it as an extra group.

12. The Monitor Bus can mirror the output of any other bus, or it can act as a separate Solo bus. See page 20.
13. The Main Mix bus is the master fader for the entire mixer. You can add EQ and Leveler compression.
14. You can adjust Aux bus output levels here, or in the Aux Mixing tab shown on page 18.
15. Click a name to change it, except for the Main Mix, Monitor, and Reverb busses, which cannot be changed.
16. Stereo toggle to switch channels pairs between mono or stereo. Use the other menus to manage channel strip presets and to choose audio sources and destinations for mixer inputs and bus outputs.
17. Gate processing for inputs.
18. The Dynamics section provides a conventional compressor for inputs and the Leveler for output busses.

19. Reverb and aux sends.

20. Solo and mute. On the Monitor bus, the SC button clears all solos.
21. Channel faders.
22. Choose the source for the Monitor bus from this menu. It can mirror any output bus or the Solo Bus.
23. When *Follow Solo* is enabled, the Monitor bus temporarily switches to the solo bus when any channel is soloed.

24. Group sends.
25. 'S' lets you solo the group. 'PRE' toggles the sends between pre- and post-fader routing, i.e. before or after the channel fader.
26. Show and hide output busses here.
27. Show/hide all busses with one click.
28. Same as (25) above.
29. Show and hide inputs here.
30. Show/hide all inputs with one click.

AUX MIXING TAB

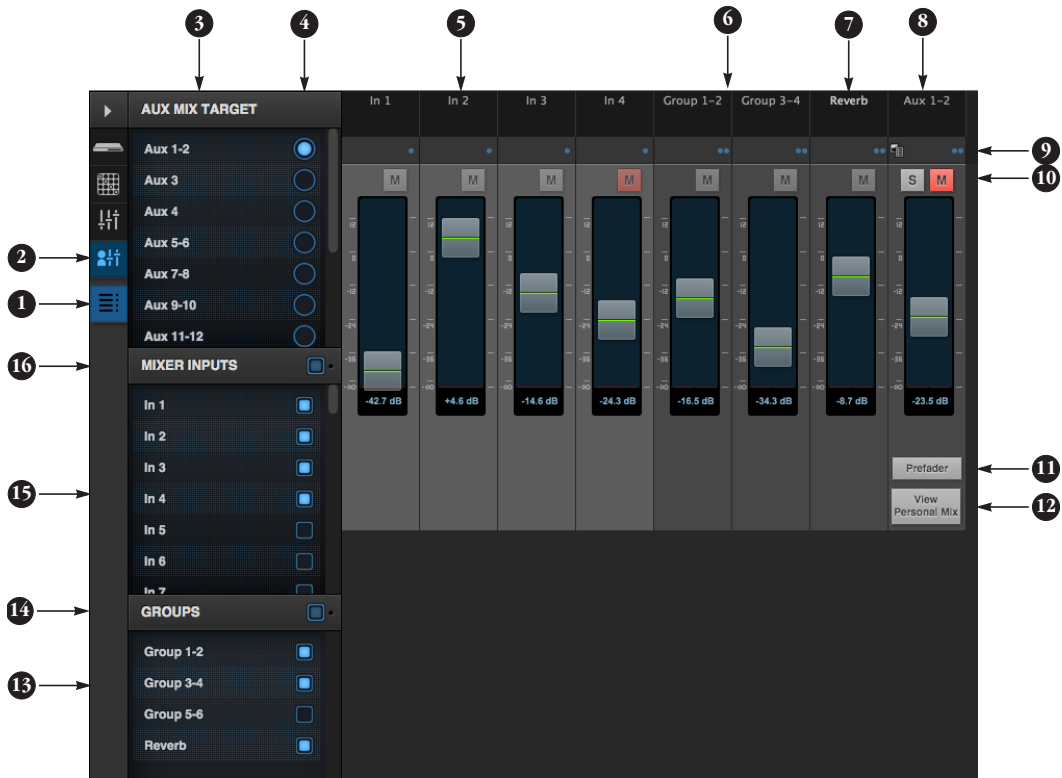

The Aux Mixing tab provides quick access to your MOTU AVB interface's mix busses (aux busses, groups and reverb bus), viewed one at a time. Choose a bus in the Aux Mix Target section and then use the faders to directly mix the send levels from all mixer inputs, groups, and the reverb bus.

- Shows and hides the Mixer Setup sidebar (3), which lets you show and hide channels.
- The Aux Mixing tab (shown on this page) gives you access to the Aux busses and groups in the mixer.
- Use the *Aux Mix Target* sidebar to control which aux bus or group you are currently viewing. You can also show/hide inputs and group sends.
- Click the aux bus or group you wish to view in the window. In this example, Aux bus 1-2 is being displayed.
- These are mixer inputs (aux sends from each mixer channel). To include an input in the aux bus mix, simply bring up its fader.
- These are group bus faders.
- This is the mixer's reverb bus fader.
- This is the master fader for the current aux bus being viewed (4).
- Indicates if the input or group is stereo or mono. Each channel's mono/stereo status cannot be toggled (unlike MIXING page).
- Solo and mute for the aux bus master fader.
- When *Prefader* is enabled, all send levels to the aux bus are independent of the main fader for each channel. In other words, changing an individual channel's main fader in the Mixing tab won't affect its send level to the aux bus.
- Click the View Personal Mix button to open a new web page that displays only that specific Aux Mix or Group.
- Show and hide mix groups and the reverb bus here.
- Use the Groups button here to show or hide all groups with one click.
- Show and hide mixer inputs (channel sends) here.
- Show and hide all mixer inputs with one click here.

MIXER INPUT CHANNEL STRIPS

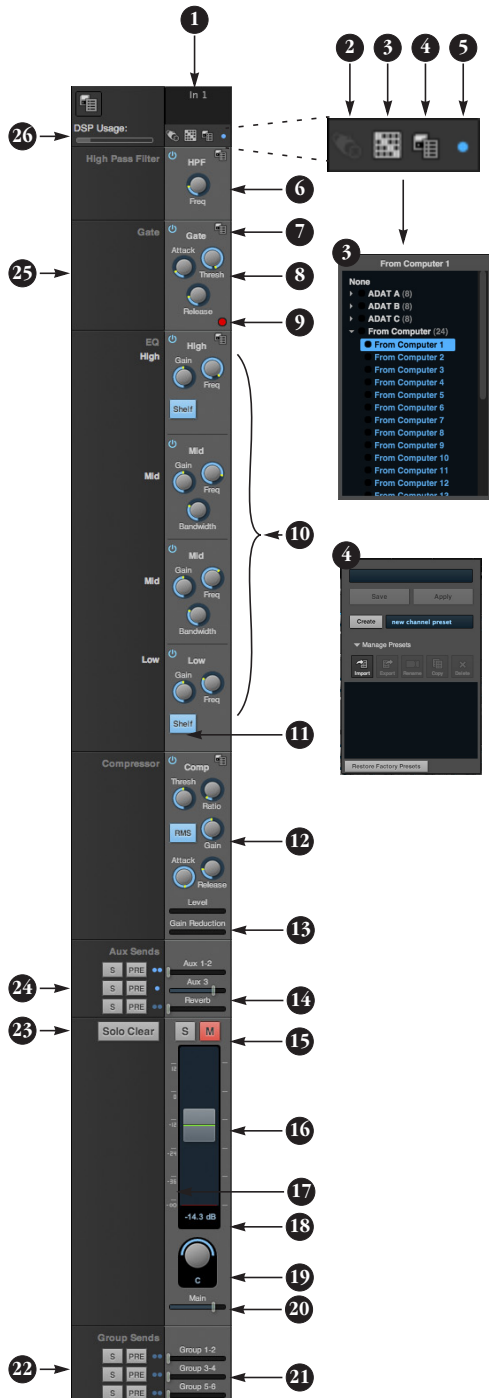

To access a mixer input channel strip, go to the Mixing tab (page 17), reveal the side bar (item #3 on page 17), and then show the input channel you want in the *Mixer Inputs* section (29).

To show and hide sections of the channel strip, such as EQ or the compressor, use the *Controls* section of the side bar (item #3 in the Mixing tab on page 17).

1. Click the input channel name to change it. Delete the current name to restore the default name.
2. Provides hardware settings for inputs, if any, on other MOTU AVB interfaces. In the case of the 24Ai and 24Ao, this is grayed out because there are no hardware settings for inputs.
3. Choose the source for the input channel. You can also make this setting directly on the Routing grid (page 16).
4. Create, name, save and recall channel strip presets.
5. Toggles the input between mono and a stereo pair.
6. High Pass Filter with cutoff frequency.
7. Each effect in the channel strip (High Pass Filter, Gate, EQ, etc.) has an on/off button (on the left) and a preset menu on the right, for managing presets that apply only to that processing module. For example, you can create your own EQ presets for the EQ modules.
8. The Gate processor provides standard attack, threshold and release controls.
9. The Gate indicator turns red when the gate is engaged.
10. The EQ section provides four bands of parametric EQ, each with standard Gain, Frequency, and Bandwidth settings.
11. The High and Low EQ bands provide a *Shelf* filter button for standard high and low shelf filtering.
12. The Compressor provides standard controls for Threshold, Ratio, Attack, Release and Gain. Normally, the compressor operates in Peak mode, where signal peaks determine the

input level. Engage the RMS button so uses RMS values (a computational method for determining overall loudness) to measure the input level.

13. Input level and gain reduction meters for the compressor.
14. Aux and reverb sends.
15. Solo/Mute. Mute affects all sends as well as the main channel. Pre-fader sends are not affected by Mute.
16. Move the fader to adjust level. Double-click to return to zero (unity gain) or $-\infty$.
17. Click the dB scale numbers to make the fader jump exactly to that level. Click and drag horizontally to jump consecutive faders to the same level.
18. Click to type in an exact dB level.
19. Channel pan. For mono inputs, double-click to center.
20. Main Mix Slider is used to feed signal to the Main Mix. Slider is set to 0 dB by default, so all channel strips are pre-routed to the Main Mix bus. If a channel is being sent to a Group (which will eventually be fed to the Main Mix), drag the slider to $-\infty$ so it is not sent to Main Mix directly.
21. Group sends.
22. 'S' lets you solo the group. 'PRE' toggles the sends between pre- and post-fader routing, i.e. before or after the channel fader.
23. Clears all solos.
24. 'S' lets you solo the Aux bus. 'PRE' toggles the sends between pre- and post-fader routing, i.e. before or after the channel fader. The dots let you toggle the Aux bus between mono and stereo.
25. This side bar, with the section labels in it, can be shown or hidden using the *Legend* switch in the *Controls* section of the side bar (item #3 in the Mixing tab on page 17).
26. Shows how much DSP power is being used by the mixer hardware. To free up DSP bandwidth, try reducing the number of mixer ins, disabling channel effects, reverb, etc. See "DSP Usage" on page 68 for more info.

MAIN MIX AND MONITOR CHANNEL STRIPS

1 **2**

3 **4** **5** **6**

7

8

9

10

11 **12**

13 **14**

3 Analog 1 Analog 2 Trim Trim

4 Main None Analog (12) Analog 1-2 Analog 3-4 Analog 5-6 Analog 7-8 Analog 9-10 Analog 11-12 Analog 13-14 Analog 15-16 Analog 17-18 Analog 19-20 Analog 21-22 Analog 23-24 ADAT A (4) ADAT B (4) ADAT C (4) To Computer (10)

5 Save Apply Create new channel preset Manage Presets Report Import Reset Cancel OK Home Restore Factory Presets

To access the Main Mix and Monitor channel strips, go to the Mixing tab (page 17) and scroll the display to the right, beyond the inputs and groups.

To show and hide sections of the channel strip, such as EQ or the Leveler, use the *Controls* section of the side bar (item #3 in the Mixing tab on page 17).

- By default, the Monitor bus serves as a solo bus. However, it can be set to mirror the main mix bus, or any other aux bus, group, or the reverb bus, in addition to monitoring solo. Make this choice in the source menu (12). Use the Routing grid (page 16) to specify the output for the Monitor bus.
- The Main Mix bus is the primary stereo mix.
- Provides hardware settings for any assigned outputs that have them. For example, if the Main Mix bus is assigned to analog outputs on the 24A0, you'll see trim settings for the outputs. This item is grayed out if there are no hardware settings for output.
- Use this output assignment widget to choose the destination — or multiple destinations — for the bus. You can also make this setting directly on the Routing grid (page 16).
- Use the preset menus to create save, recall, and otherwise manage channel strip presets for the Monitor bus and Main Mix bus.
- Indicates that the bus is stereo.
- The four-band parametric EQ for the Main Mix bus operates the same as described for input channels (items 10 and 11 on page 19), including High and Low Shelf filter options.
- The Leveler provides specialized gain reduction modeled after the legendary Teletronix LA-2A Leveling Amplifier. For complete details, see "Leveler" on page 66.
- Mutes for the Main Mix bus and Monitor bus.
- Master faders for the Main Mix bus and Monitor bus. Use the same techniques described for input channel faders (items 16, 17 and 18 on page 19).
- When *Follow Solo* is enabled, the Monitor bus switches to the solo bus when any channel is soloed. NOTE: if an aux bus is soloed, then the Monitor bus carries only the soloed aux bus (any current channel solos are excluded).
- Choose the source for the Monitor bus from this menu. It can mirror the main mix, any aux bus, group, the reverb bus, or it can serve only as a Solo bus.
- The SC button clears all solos.
- This mid-band EQ is currently disabled (and therefore grayed out).

AUX BUS CHANNEL STRIPS



Aux busses can be used to create sub-mixes. An aux bus can be assigned to any output in the Routing grid (page 16).

To access an Aux bus channel strip, go to the Mixing tab (page 17), reveal the side bar (item #3 on page 17), and then show the aux busses you want in the *Mixer Outputs* section (26).

To show and hide the four-band EQ section of the channel strip, use the *Controls* section of the side bar (item #3 in the Mixing tab on page 17).

1. A stereo aux bus.
2. A mono aux bus.
3. Click this dot to toggle an aux bus between mono and stereo.
4. The four-band parametric EQ module for Aux busses operates the same as described for input channels (items 10 and 11 on page 19), including High and Low Shelf filter options.
5. Aux bus solo and mute.
6. Aux bus master fader.
7. Click to type specific value manually.
8. Click the dB scale numbers to make the fader jump exactly to that level. Click and drag horizontally to jump consecutive faders to the same level.
9. A disabled EQ band.
10. Use these menus (hardware settings, output assignment, and presets) in a similar fashion as described for the Main Out bus (items 3-5 on page 20).

GROUP AND REVERB CHANNEL STRIPS



Group buses can be used to create a mix sub-group, which is a set of inputs you wish to control together as a group. Groups differ from aux buses in that they have aux sends, a reverb send, as well as a main mix send. In addition, group buses are equipped with the Leveler.

The Reverb bus is a special group bus that provides a reverb processor. If you disable the reverb, the reverb bus functions as a (fourth) regular group bus.

To access the Group and Reverb bus channel strips, go to the Mixing tab (page 17), reveal the side bar (item #3 on page 17), and then show the desired Group buses or Reverb bus in the *Mixer Outputs* section (26).

To show and hide the four-band EQ section of the channel strip, use the *Controls* section of the side bar (item #3 in the Mixing tab on page 17).

1. A Group bus channel strip. Click the name to rename it. Delete the current name to return to its default.
2. The Reverb bus. If you disable the Reverb processor, it can be used as a fourth Group bus. The Reverb channel strip is twice as wide as other mixer channel strips to accommodate the Reverb processor controls.
3. Group buses and the Reverb bus are always stereo.
4. The four-band parametric EQ module for Group buses and the Reverb bus operates the same as described for input channels (items 10 and 11 on page 19), including High and Low Shelf filter options.
5. The Reverb processor. For complete information, see "Reverb" on page 67.
6. Main Mix sends.
7. Master faders for the Group and Reverb buses.
8. Mute and Solo.
9. Use these menus (hardware settings, output assignment, and presets) in a similar fashion as described for the Main Out bus (items 3-5 on page 20).

CHAPTER 1 About Your MOTU AVB Audio Interface

The 24Ai and 24Ao are hybrid USB2/AVB audio interfaces with 48-channel digital mixers and AVB Ethernet networking capability. They can operate as audio interfaces for a computer, as stand-alone digital mixers, as gateways to an expanded studio system, as components of an extended AVB audio network, or as capable hybrid devices performing all of these roles simultaneously.

Together, they are designed to be a central component of a modern, high performance recording studio or live mixing platform. The following sections provide a brief overview of their main features and characteristics.

State-of-the-art A/D and D/A conversion

The analog section of each interface employs state-of-the-art 24-bit DACs or ADCs, which deliver analog recording and playback with remarkably high dynamic range at sample rates from 44.1 to 192 kHz.

Complementary I/O configurations

Each interface delivers an exceptional amount of analog and digital audio. In addition, the interfaces are designed to complement each other, and MOTU's other AVB-equipped audio interfaces, to deliver a wide range of I/O options; you can mix and match several interfaces and operate them as a unified I/O and mixing system. The following sections provide a bird's-eye glance of the I/O configurations offered by each interface in the MOTU AVB family.

Each interface provides a variety of analog and digital interconnects, all active simultaneously, designed to provide everything you need for a well-equipped recording studio.

24Ai

72 simultaneous audio channels

Connection	Input	Output
Balanced analog on 3x D-sub or 6x Phoenix	24	-
ADAT optical digital (at 44.1 or 48 kHz)	24	24
Total	48	24

24Ao

72 simultaneous audio channels;

Connection	Input	Output
Balanced analog on 3x D-sub or 6x Phoenix	-	24
ADAT optical digital (at 44.1 or 48 kHz)	24	24
Total	24	48

Network I/O

Each interface is also capable of handling additional 8-channel banks of network audio input and output for an additional 96 simultaneous audio channels.

Other MOTU AVB interfaces

The 24Ai and 24Ao are part of a larger family of audio interfaces, summarized below, with complementary I/O configurations.

1248

66 simultaneous audio channels

Connection	Input	Output
Quarter-inch analog on bal/unbal TRS	8	12
Mic inputs with individual preamps on XLR	4	-
Hi-Z guitar inputs	2	-
Headphone output	-	2 x stereo
ADAT optical digital (at 44.1 or 48 kHz)	16	16
RCA S/PDIF digital up to 96 kHz with SRC	stereo	stereo
Total	32	34

8M

50 simultaneous audio channels

Connection	Input	Output
Quarter-inch analog on bal/unbal TRS	-	8
Mic/guitar inputs on combo XLR/TRS	8	-
Headphone output	-	stereo
ADAT optical digital (at 44.1 or 48 kHz)	16	16
Total	24	26

16A

64 simultaneous audio channels

Connection	Input	Output
Quarter-inch analog on bal/unbal TRS	16	16
ADAT optical digital (at 44.1 or 48 kHz)	16	16
Total	32	32

Universal connectivity

The 24Ai and 24Ao can connect to a computer with high-speed USB 2.0, which is compatible with USB 3.0). They are USB audio class-compliant, which means that they are iPad compatible (with a camera connection kit) and do not require driver installation for USB connection to a computer.

Alternately, the 24Ai and 24Ao can be connected to the Ethernet port on a recent-generation Mac (any Mac with Thunderbolt on it) running Mac OS X Yosemite (10.10) or later for audio interface operation through AVB Ethernet.

On-board DSP with mixing and effects

Each interface is equipped with a powerful DSP engine that drives both an extensive routing matrix and a 48-input digital mixer with 12 stereo busses and effects. The mixer offers familiar operation modeled after large format mixing consoles.

32-bit floating point processing

All of the mixing and effects processing in the DSP engine is handled with 32-bit floating point calculations, to maintain and deliver virtually unlimited headroom and the utmost in sound quality.

Modeled vintage effects processing

Effects include “classic” reverb, compression modeled after the legendary Teletronix LA-2A compressor, and 4-band EQ modeled after British analog console EQs.

AVB system expansion and audio networking

AVB stands for the IEEE 802.1 *Audio Video Bridging* Ethernet standard for high-bandwidth, low-latency audio streaming over Ethernet. The AVB Ethernet network port on each MOTU interface lets you add a second AVB-equipped MOTU interface using any standard CAT-5e Ethernet cable. You can network up to five MOTU interfaces together using a MOTU AVB Switch™ (sold separately), and then run them as a stand-alone network or as an extended bank of I/Os for your computer-based production system (or both). You can even connect multiple computers, each with full access to all devices on the network (including the other computers).

With additional standard AVB switches (from MOTU or other brands) and standard Ethernet cabling, you can build an extensive AVB audio network. The entire network operates with near-zero network latency, even over very long cable runs. MOTU’s AVB implementation allows you to stream hundreds of audio channels among devices and computers on the network with guaranteed Quality of Service (QoS), prioritizing audio streams over less important traffic.

Matrix routing and multing

Each MOTU interface provides completely flexible matrix-style audio routing and multing. You can route any analog or digital input, computer

channel, or network stream to any other output, computer, or network device. You can also mult any single input to unlimited multiple output destinations.

24 channels of network audio I/O for your host computer

The 24Ai and 24Ao let you stream up to 24 audio channels in and out, simultaneously, through their USB connection to a host computer. Sources and destinations can include inputs and outputs on the device, inputs and outputs on other interfaces on the network, and even audio software apps running on other computers connected to other devices on the network.

Web app control

You can control on-board DSP, mixing, device settings, clock/sync settings, and network audio routing from the MOTU AVB Control web app software running in your favorite browser on a laptop, tablet or smart phone connected to your MOTU interface directly, or through your local WiFi network. Multiple devices can be used simultaneously to access any audio interface settings on the network.

Stand-alone mixing with wireless control

If you connect your MOTU interface to an Apple Airport or other WiFi router with a standard Ethernet cable, you can control its powerful mixing and DSP effects from your smart phone or tablet, without a computer — great for live sound mixing from your iPad, tablet, or other wireless device.

ADAT digital I/O

The 24Ai and 24Ao interfaces each provide three 8-channel banks of optical digital I/O. Connect outboard digital processors, digital mixers or other gear: 24 channels at 44.1/48 kHz or 12 channels at 88.2/96 kHz.

Word clock

Each MOTU interface supports standard word clock synchronization at any supported sample rate. When the interface is operating at 96 kHz, it can generate word clock output at either 96 or 48 kHz; the 1x equivalence is available as an option for word clock output when running at high sample rates (from 88.2 to 192 kHz). The word clock OUT port can alternately be used as a THRU port for word clock daisy-chaining. To configure, use the LCD menu to navigate to Settings -> Word Clock Thru Mode.

Comprehensive metering

The large backlit LCD displays all signal activity at a glance with detailed metering for all analog and digital I/O. You can access many hardware settings directly from the front panel.

Precision Digital Trim™

Analog inputs are equipped with digitally controlled analog trims, adjustable in 1 dB increments. Analog outputs offer 32 bit trim in the DAC, also adjustable in 1 dB increments. You can save your trim configurations as a preset for instant recall.

Rack mount or desktop operation

Each interface is housed in a sturdy, metal-alloy, 19-inch, rack-mountable unit. The rack mounting brackets can be removed using a 7/64" hex wrench for desktop operation.

AudioDesk

AudioDesk is a full-featured audio workstation software package for Mac and Windows that is available as a free download for you as a 24Ai or 24Ao owner. Visit motu.com/avb to obtain your copy. AudioDesk provides multi-channel waveform editing, automated virtual mixing, graphic editing of ramp automation, real-time effects plug-ins with crossfades, support for many third-party audio plug-ins, sample-accurate editing and placement of audio, and more.

CHAPTER 2 **Packing List and System Requirements**

PACKING LIST

Your MOTU interface ships with the items listed below. If any of these items are not present in the box when you first open it, please immediately contact your dealer or MOTU.

- One audio interface
- One USB cable
- One power cord
- One manual
- Product registration card

SYSTEM REQUIREMENTS

- A 1 GHz Intel-based Mac or Pentium-based PC (or compatible). Faster CPUs are recommended for best performance.
- 2 GB RAM; 4 GB or more recommended.
- OS X 10.8 or later; Windows 7 or later; for operation as an AVB Ethernet audio interface, Mac OS X 10.10 or later is required, running on a recent-generation Mac (any Mac with a Thunderbolt port on it).
- Available high-speed USB 2.0 (or 3.0) port
- A large hard drive (preferably at least 500 GB)

PLEASE REGISTER TODAY!

Please register your MOTU interface today. There are two ways to register.

- Visit www.motu.com/register

OR

- Fill out and mail the included product registration card

As a registered user, you will be eligible to receive technical support and announcements about product enhancements as soon as they become available. Only registered users receive these special update notices, so please register today.

Thank you for taking the time to register your new MOTU products!

CHAPTER 3 Software Installation

OVERVIEW

USB 2.0 class-compliant operation.....	29
Operation as an AVB Ethernet audio interface	29
Software installation.....	29
Audio drivers	30
MOTU AVB Discovery app for Mac	30
MOTU AVB WebUI Setup for Windows	30
MOTU AVB USB Control Panel	30
AudioDesk workstation software	31
Working with host audio software.....	31

USB 2.0 CLASS-COMPLIANT OPERATION

Your MOTU interface is a USB 2.0 audio class-compliant device. This means that you can connect it to your Mac with a USB cable and use it without installing any software drivers. The computer recognizes your MOTU interface as a USB audio device and makes its inputs and outputs available to your host audio software. Basic settings, such as the hardware’s sample rate, are made in either your host software (Mac) or your system settings (Windows).

☛ In this scenario, your MOTU interface provides basic audio input and output, and no software driver installation is necessary.

As explained earlier in this guide, the MOTU AVB Control web app provides full access to all settings in the device, including the extensive on-board routing, mixing, and effects processing features. Since the web app is served from the audio interface hardware itself, it does not require any software installation on your computer; all it requires is a network connection between your computer and your MOTU interface with a standard Ethernet cable, Ethernet hub, or shared Wi-Fi network. For details about accessing the web app through the network port, see “MOTU AVB Control Web App” on page 13.

OPERATION AS AN AVB ETHERNET AUDIO INTERFACE

To use your MOTU interface as an audio interface over AVB Ethernet, all you need is a recent Mac (any Mac that has a Thunderbolt port on it) with Mac OS X Yosemite (10.10) or later installed. Connect the network port on your MOTU interface to the Ethernet port on the Mac using a standard, high-grade (CAT-5e or CAT-6) network cable up to 100 meters in length. You can then use your MOTU interface as a standard, low-latency multi-channel audio interface with any Core Audio compatible host software running on the Mac.

☛ In this scenario, your MOTU interface provides basic audio input and output, and no software driver installation is necessary.

For details about accessing device settings in the web app through a network port connection, see “MOTU AVB Control Web App” on page 13.

SOFTWARE INSTALLATION

Software installation is required for any of the following scenarios:

- You are using a PC running Windows 7 or later.
- You will use your MOTU interface as a USB audio interface, and you want to access the web app without the network port.
- You will be using multiple MOTU interfaces.

If none of the above scenarios apply to you, then you can skip software installation if you wish, and proceed to details about accessing the web app through the network port, see “MOTU AVB Control Web App” on page 13.

Download and run the MOTU AVB Audio Installer

To download the latest MOTU AVB audio installer for Mac or Windows, visit www.motu.com/avb. Follow the directions that the installer gives you.

☛ We recommend that you run the software installer *before* you connect your MOTU interface to your computer and power it on. This ensures that all driver components are properly installed in your system.

AUDIO DRIVERS

On the Mac, no USB audio driver is installed because your MOTU interface is USB audio class compliant, and USB audio operation is handled by Mac OS X. On Windows, the installer provides USB ASIO and Wave drivers.

MOTU AVB USB ASIO Driver

On Windows, to enable your MOTU interface in your ASIO host software, choose the MOTU AVB USB ASIO driver.

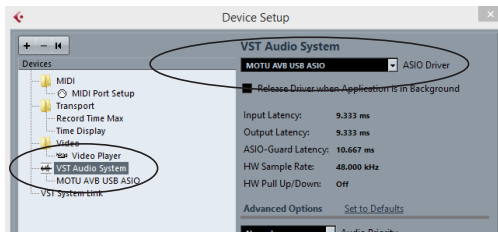

Figure 3-1: Choosing the MOTU AVB ASIO driver in Cubase.

MOTU AVB DISCOVERY APP FOR MAC

On the Mac, the MOTU AVB Discovery app is installed in your Mac's applications folder; a shortcut is installed for it, too (as shown on page 13). It locates all MOTU AVB interfaces connected to the Mac, either directly through USB or on your network, and displays them in a list. Choose an interface to access its settings through the web app ("MOTU AVB Control Web App" on page 13).

MOTU AVB WEBUI SETUP FOR WINDOWS

On Windows, the installer provides a *MOTU AVB WebUI Setup* shortcut found on the Windows desktop or in *Start menu > All Programs > MOTU*. Use this shortcut to access the MOTU AVB Control web app directly in your favorite web browser.

MOTU AVB USB CONTROL PANEL

On Windows, the MOTU AVB USB Control Panel (*Start menu > All Programs > MOTU*) provides three tabs: Status, Buffer Settings and Info. The Buffer Settings tab provides several basic settings for the AVB USB driver.

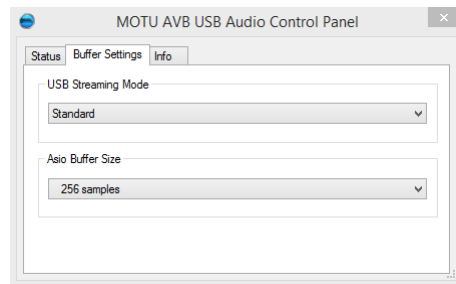

Figure 3-2: The MOTU AVB USB Audio Control Panel Buffer Settings tab.

USB Streaming Mode

USB Streaming Mode (Figure 3-2) determines how frequently the USB driver transfers audio. Smaller settings reduce latency. This setting determines the latency for standard Windows audio applications (such as Media Player). For further information about latency, see "Reducing monitoring latency" on page 59.

ASIO Buffer Size

ASIO Buffer Size (Figure 3-2) determine how much delay you hear when monitoring live inputs through your audio software: larger buffers produce more delay; smaller buffers produce less. For complete information about this setting, see "Working with Host Audio Software" on page 55.

AUDIODESK WORKSTATION SOFTWARE

AudioDesk is an advanced workstation software package that lets you record, edit, mix, process, bounce and master multi-track digital audio recording projects. Advanced features include real-time effects processing, recording, and much more.

See the *AudioDesk User Guide*, available on your computer hard drive as a PDF document.

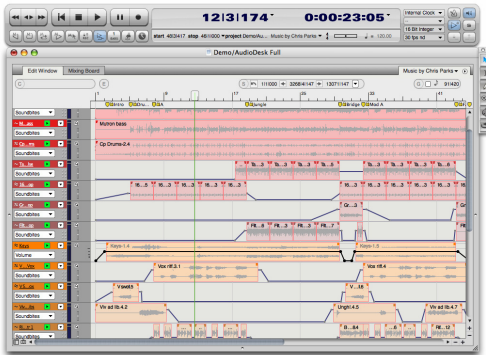

Figure 3-3: AudioDesk.

WORKING WITH HOST AUDIO SOFTWARE

For further information about using your MOTU interface with host audio software, see “Working with Host Audio Software” on page 55.

CHAPTER 4 Hardware Installation

OVERVIEW

Rack installation and heat	33
USB audio interface setup	33
AVB Ethernet audio interface setup.....	34
Setup for two interfaces	34
Setup for three to five interfaces.....	35
Setup for a multi-switch network	36
Setup for multiple interfaces.....	37
Setup for web app control	38
Audio connections.....	40
Synchronization	40
Syncing optical devices	41
Syncing word clock devices.....	41
Syncing an AVB network.....	42
Syncing multiple AVB audio interfaces connected to a Mac	43

RACK INSTALLATION AND HEAT

When installing your MOTU audio interface in a 19-inch rack, leave extra space above, below, behind and on either side of the unit to provide adequate ventilation and heat dispersion. Do not install it near other gear that generates excessive heat.

USB AUDIO INTERFACE SETUP

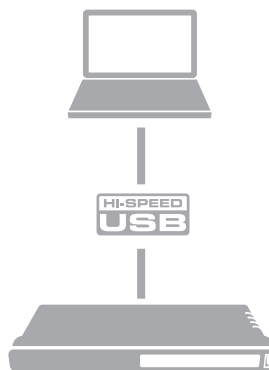

Use this setup if you want to use your MOTU device as an audio interface.

- Use a standard USB cable.
- Connect to any USB port (USB2.0 or 3.0).
- See “USB2.0 class-compliant operation” on page 33.
- No driver installation is necessary (unless you want to use the web app).

AVB ETHERNET AUDIO INTERFACE SETUP



Use this setup if you want to use the 24Ai or 24Ao as an AVB Ethernet audio interface for a recent-generation Mac (i.e. any Mac with a Thunderbolt port on it). Mac OS X Yosemite (10.10) or later is also required for AVB audio I/O.

- Use a standard CAT-5e or CAT-6 cable.
- Connect to the computer's Ethernet port.
- See “Operation as an AVB Ethernet audio interface” on page 29.
- No driver installation is necessary.
- Enable at least one AVB stream (item #19 on page 15).
- Launch the Mac's Audio MIDI Setup utility to enable the 24Ai or 24Ao and set the clock source and sample rate.
- The number of AVB audio channels that OS X can handle depends on the speed of your Mac.
- If applicable, see “Syncing multiple AVB audio interfaces connected to a Mac” on page 43.

About CAT-5e cables

Use shielded *CAT-5e* or *CAT-6* cables, which are a higher grade version of a standard Ethernet cable. They are available wherever network cables are sold.



SETUP FOR TWO INTERFACES

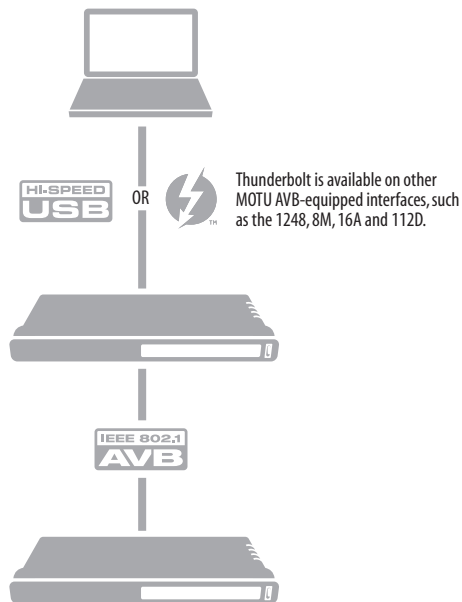

Use this setup if you want to connect two MOTU interfaces to your computer.

- The connection to the computer can be either USB or Thunderbolt, if you have a Thunderbolt-equipped MOTU AVB interface such as the 1248, 8M, 16A or 112D.
- Use a standard Thunderbolt cable. Place it at the end of the Thunderbolt chain.
- Use any standard CAT-5e Ethernet network cable to connect the two interfaces together using their NETWORK ports.
- As an alternative, see “Setup for multiple interfaces” on page 37.

SETUP FOR THREE TO FIVE INTERFACES

Use this setup if you want to connect three to five MOTU interfaces to your computer using a MOTU AVB Switch™ (sold separately).

- The connection to the computer can be USB or Thunderbolt (if you have a Thunderbolt-equipped MOTU AVB interface). Use Thunderbolt, if possible, to support a large number of audio streams to and from the networked interfaces. A single Thunderbolt connection supports 128 channels in and out, simultaneously. If you need more channels, and your computer has another available Thunderbolt or USB port, you can make a second connection, with full access to the network from both ports.

- Use standard CAT-5e Ethernet network cables to connect the interfaces to the MOTU AVB Switch using their NETWORK ports.
- Use the five AVB NETWORK ports on the switch (not the Ethernet port).
- Network cable lengths can be long: 100 meters with standard copper wire cables; much longer with fiber-optic network cables.
- See “About CAT-5e cables” on page 34.
- As an alternative, see “Setup for multiple interfaces” on page 37.
- To add more computers to the network, connect them to any interface, as shown. All computers and interfaces have full access to each other.
- See chapter 9, “Networking” (page 69).

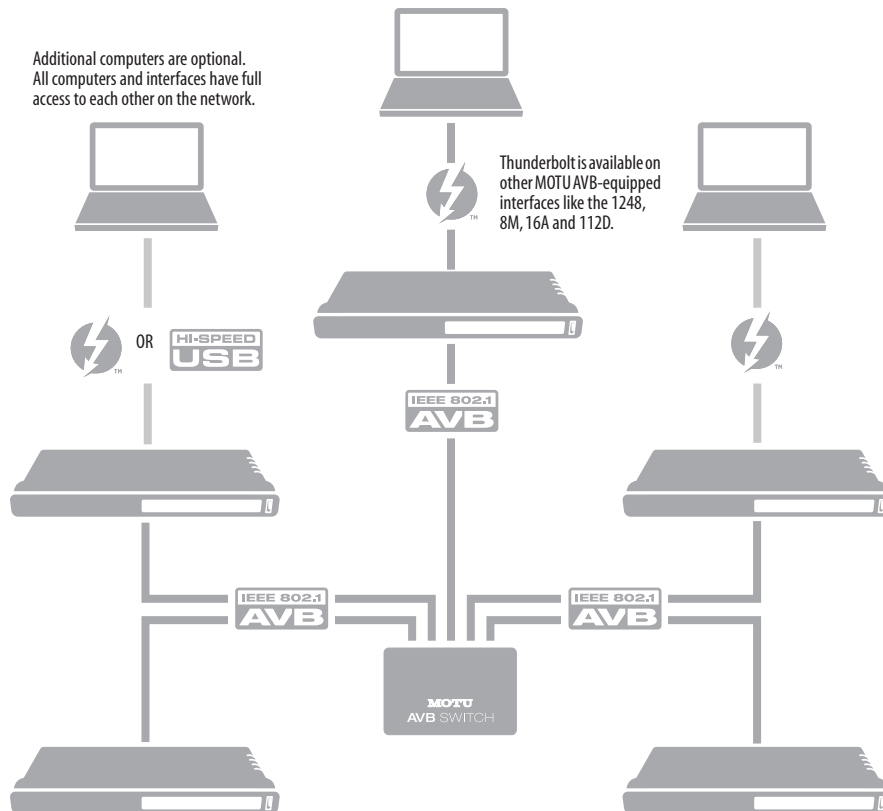

SETUP FOR A MULTI-SWITCH NETWORK

Use this setup if you want to connect more than five MOTU interfaces to an extended network that employs multiple AVB switches. AVB Ethernet is an industry standard, so you can use MOTU AVB Switches or 3rd-party AVB switches.

- You can daisy-chain switches in serial fashion, but don't create loops. For example, switches A, B, and C below are chained properly, but don't connect C back to A. Alternately, you could connect both Switches B and C to Switch A.

- For further information, see chapter 9, "Networking" (page 69).

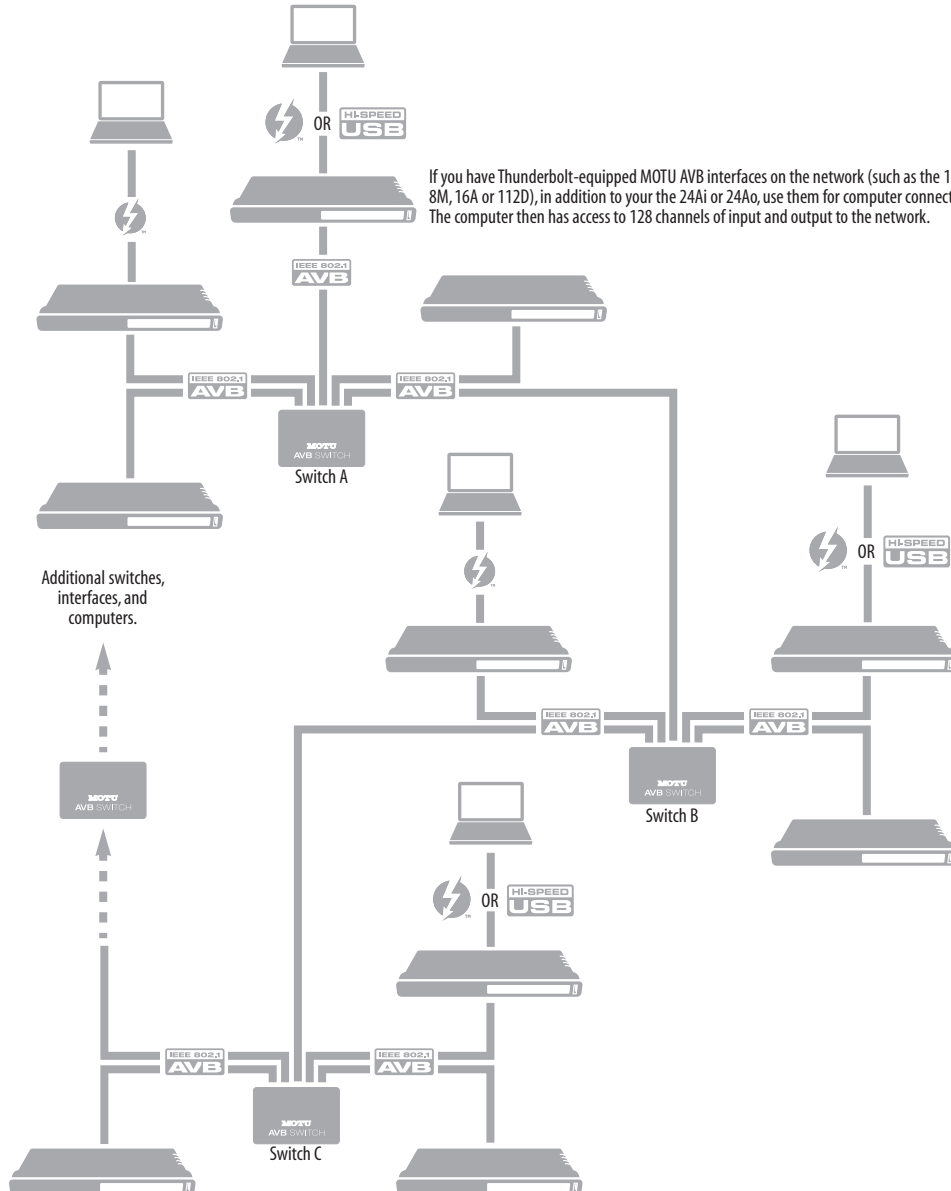

SETUP FOR MULTIPLE INTERFACES

It is possible to connect multiple MOTU interfaces directly to your host computer through multiple USB (and Thunderbolt) ports. Alternately, you can connect multiple interfaces, operating as AVB Ethernet audio interfaces, using an AVB switch connected directly to the Mac. However, there are several disadvantages to using any of these direct connection schemes:

- The audio interfaces will not be clocked to one another and may be susceptible to drift, unless you use external word clock connections (if available). You are better off using the AVB network connections shown on pages 34-36. In this setup, the interfaces are very tightly synchronized with each other (measured in pico seconds) through their network connections.
- You will not be able to route audio directly from one audio interface to another. You are better off using the AVB network connections shown on pages 34-36, which allows you to route audio streams (hundreds at a time) directly among interfaces with near-zero latency.

Connecting multiple interfaces using Thunderbolt

If you have other MOTU AVB interfaces with Thunderbolt connectivity (1248, 8M, 16A or 112D) and your host computer has two or more Thunderbolt ports, you can connect one interface to each port, either directly or at the end of a Thunderbolt daisy chain (on either port or both ports).

Connecting multiple interfaces using Thunderbolt and USB

Another way to operate multiple interfaces on the same host computer is to connect the first interface to a Thunderbolt port and the second to a USB 2.0 (or 3.0) port.

Multiple interfaces and USB

When connected through USB, your MOTU interface operates as a USB 2.0 device, even when connected to a USB 3.0 port. USB 2.0 provides enough bus speed for several USB 2.0 devices, but due to your MOTU interface's high-performance requirements for real-time operation and low latency timing, we recommend the following:

- Do not connect more than two units to your computer's USB 2.0 or 3.0 port(s).
- When two units are connected with USB 2.0, don't connect other USB 2.0 or 3.0 devices, such as external hard drives.
- For best results, establish clock synchronization with other interfaces connected to the same computer. You can use optical or AVB to achieve clock synchronization.

Multiple AVB Ethernet audio interfaces

When operating your MOTU interface as an AVB Ethernet audio interface ("AVB Ethernet audio interface setup" on page 34), multiple AVB audio interfaces can be connected using a MOTU AVB Switch (or any 3rd-party AVB switch), and the Mac can see all of them through their AVB connection. For example, you could connect an Avid S3 console to the Mac, and then connect a MOTU interface to the S3's extra network port (which is a built-in switch). The Mac can see both the MOTU interface and S3 for audio I/O. However, OS X takes over each device for exclusive use, so they can only stream audio to and from the Mac, not each other. The same is true for all AVB devices connected to the Mac. See "Syncing multiple AVB audio interfaces connected to a Mac" on page 43.

Mixing and matching audio interfaces

You can mix and match MOTU audio interfaces. For example, you could connect a 1248 through Thunderbolt and another MOTU audio interface, such as the 24Ao, through USB 2.0.

SETUP FOR WEB APP CONTROL

The MOTU AVB Control web app gives you access to all settings, routing, mixing, and effects processing in your audio interface, and each interface on the AVB network, if applicable. For more info, see “MOTU AVB Control Web App” on page 13.

The web app is a web application served by the hardware. All you need to run it is a web browser running on a device that has a connection to your audio interface through USB or a shared network.

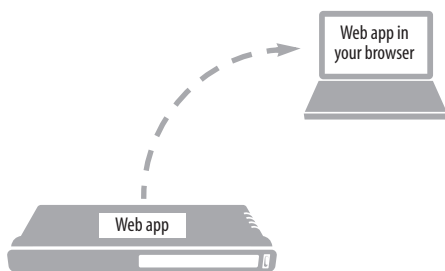

Figure 4-1: The web app is served from the hardware, and accessed through any web browser on any device connected to the interface.

Web app control can be set up independently of audio connections

The connections in this section, especially the network scenarios, can be set up independently of USB or AVB networking connections you make for audio routing (as shown in the setup diagrams earlier in this chapter). In addition, connections for web app control can be made over standard Ethernet and do not require AVB Ethernet connections. Think of web app control as being separate from audio. Doing so opens up a lot of possibilities for control of your MOTU interface, independent of the connections you make for audio.

Mixing and matching web app control scenarios

The web app connection scenarios shown in the following sections are not exclusive from one another. You can set up as many web app connections as you wish and control your MOTU device from many web app hosts simultaneously.

Launching the web app

Once you’ve made any of the connections shown in the following sections, launch the web app as explained in “Make hardware and network connections” on page 13.

Web app control over USB or Thunderbolt

If your audio interface is connected a computer with internet access through USB (as shown on page 33), you can access the web app from the computer, or any other device on the network. In this case, make sure you’ve run the software installer (page 29), which installs drivers that allow your computer to properly communicate with the device.

Web app control through standard Ethernet

Your MOTU interface can also be controlled by the web app running on any device that has a standard Ethernet connection to the interface, either directly with a network cable, through an Ethernet hub, or through WiFi on your local network. The sections on the opposite page show you how to set up each of these connection scenarios.

Ethernet cable

A simple Ethernet cable connection can be used for web app control, even without a USB or Thunderbolt connection to your computer. For example, if you are using your MOTU device as a mixer or audio router, you could control the on-board routing, mixing and effects from the web app through a standard Ethernet connection.

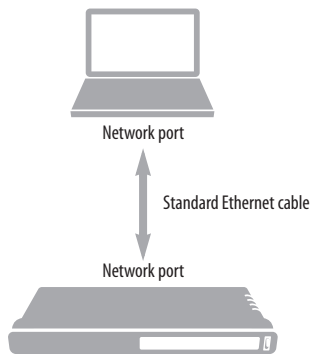

Figure 4-2: Web app control through a simple Ethernet cable.

Ethernet hub or network (LAN)

In this scenario, both your laptop and your MOTU device are connected to a standard Ethernet hub or home/office network (LAN). You can run the web app on multiple computers simultaneously.

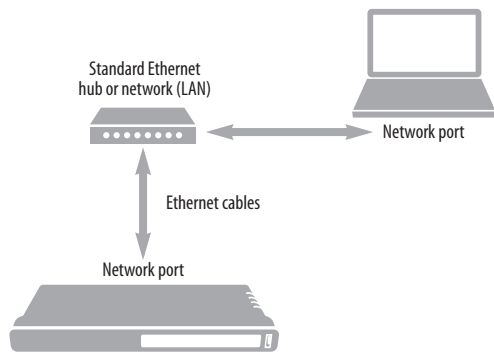

Figure 4-3: Web app control through a standard Ethernet hub or network (LAN).

WiFi

When using standard WiFi as shown, you can control your MOTU interface from multiple WiFi devices simultaneously.

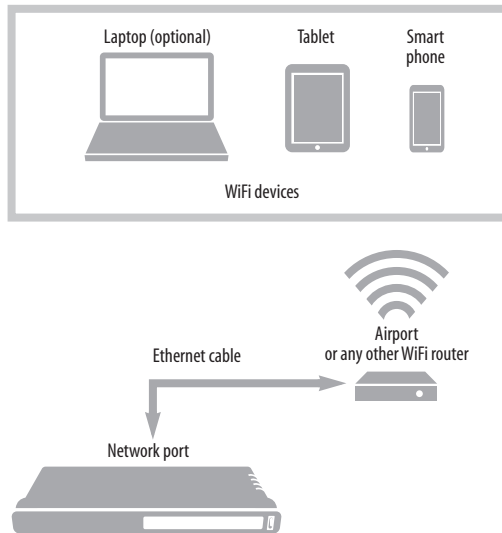

Figure 4-4: Web app control through WiFi.

Ethernet network + WiFi

You can, of course, combine the setups shown in Figure 4-3 and Figure 4-4, with WiFi connected to the Ethernet hub or network.

MOTU AVB Switch

The MOTU AVB Switch provides five AVB Ethernet ports, plus one standard Ethernet port. Use the AVB ports for MOTU audio interfaces, and use the Ethernet port for WiFi, Ethernet, etc.

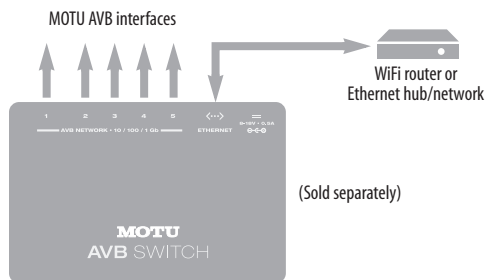

Figure 4-5: Using the Ethernet port on the MOTU AVB Switch.

AUDIO CONNECTIONS

Here are a few things to keep in mind as you are making audio connections to your 24Ai or 24Ao interface.

D-Sub connectors

The 24Ai and 24Ao D-Sub connectors accept standard, female Panasonic/Tascam (AES-59) D-sub cables. Be sure the screws have standard 4-40 threading (not metric threading). For details and pin-outs, see Appendix D, “D-sub Connector Specifications” page (85).

Analog trims

All quarter-inch analog inputs and outputs can be trimmed. This allows them to support a variety of standards, including EBU-R68, SMPTE RP-155, +4dBu, -10dBV, 2vRMS, 1vRMS.

24Ai analog inputs are equipped with high-quality, digitally controlled analog trim that provides a range from -96 to +22 dB in 1dB steps.

24Ao outputs can be trimmed in the DAC at 32 bit resolution. Range is 24 dB.

Trim controls are most easily accessed in the web app. See “Device tab” on page 14. Trim settings can also be accessed in the LCD menu.

Optical

Your MOTU interface provides three banks of ADAT optical (“lightpipe”) connectors. Together, they provide 24 channels of ADAT optical digital I/O at 44.1 or 48 kHz. At the high sample rates (88.2 or 96 kHz), 4-channel SMUX operation provides 12 channels of I/O and supports two modes (item #24 on page 15):

- *Standard* — for 2x optical connection to 3rd-party SMUX-compatible hardware products.
- *Type II (Legacy)* — for 2x optical connection to legacy MOTU products that are equipped with optical ports and support 2x operation.

The optical ports are disabled when the interface is operating at a 176.4 or 192 kHz.

TOSLink (optical S/PDIF)

Alternately, the optical ports can be configured for stereo TOSLink (optical S/PDIF) in the web app (item #24 on page 15). The optical IN and OUT banks can be configured independently.

SYNCHRONIZATION

If you connect devices digitally to your MOTU device, or if you need to synchronize your MOTU device with an outside time reference such as word clock, you must pay careful attention to the synchronization connections and clock source issues discussed in the next few sections.

Do you need to sync?

If you will be using only your MOTU device’s analog inputs or outputs (and none of its digital I/O), and you don’t need to resolve your system to external word clock, you don’t need to make any sync connections. You can skip this section.

Situations that require synchronization

There are two general cases in which you will need to resolve you MOTU device with other devices:

- Synchronizing with other digital audio devices so that their digital audio clocks are *phase-locked* (as shown in Figure 4-6)
- Resolving your MOTU device to an external clock source
- Networking multiple MOTU AVB interfaces

Synchronization is critical for clean digital I/O

Synchronization is critical in any audio system, but it is especially important when you are transferring audio between digital audio devices. Your success in using the digital I/O features on your MOTU device depends almost entirely on proper synchronization. The following sections guide you through several recommended scenarios.

Be sure to choose a digital audio clock master

When you transfer digital audio between two devices, their audio clocks must be in phase with one another — or *phase-locked*. Otherwise, you'll hear clicks, pops, and distortion in the audio — or perhaps no audio at all.

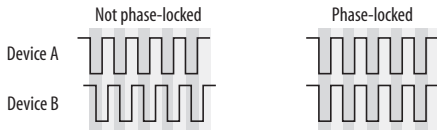

Figure 4-6: When transferring audio, two devices must have phase-locked audio clocks to prevent clicks, pops or other artifacts.

There are two ways to achieve phase lock: slave one device to the other, or slave both devices to a third master clock. If you have three or more digital audio devices, you need to slave them all to a single master audio clock.

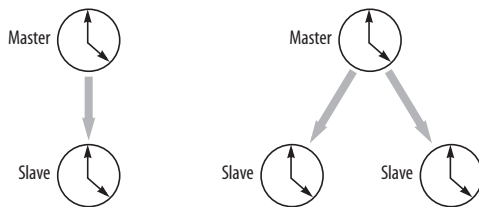

Figure 4-7: To keep your MOTU interface phase-locked with other digital audio devices connected to it, choose a clock master.

Also remember that audio phase lock can be achieved independently of timecode (location). For example, one device can be the timecode master while another is the audio clock master, but only one device can be the audio clock master. If you set things up with this rule in mind, you'll have trouble-free audio transfers with your MOTU hardware.

SYNCING OPTICAL DEVICES

There are several ways to sync an optical device with the 24Ai or 24Ao:

- Resolve the other device to the 24Ao
- Resolve the 24Ai to the other device
- Resolve both devices to a word clock source

C. Resolve both devices to a word clock source

For A, choose *Internal* (or anything other than *Optical*) as the clock mode in the Device tab (item #13 on page 14). Then configure the other device to resolve to its optical input.

For B, choose *Optical* as the clock mode (item #13 on page 14), and configure the other device to resolve to its own internal clock.

For C, choose *Word Clock* as the clock mode for the 24Ai or 24Ao (item #13 on page 14), and resolve the other device to its word clock input.

SYNCING WORD CLOCK DEVICES

The word clock connectors on your MOTU device allow you to synchronize it with a wide variety of other word clock-equipped devices.

For standard word clock sync, you need to choose an audio clock master (as explained in “Be sure to choose a digital audio clock master” on page 41). In the simplest case, you have two devices and one is the word clock master and the other is the slave as shown below in Figure 4-8 and Figure 4-9.



Figure 4-8: Slaving another digital audio device to your MOTU device (a 24Ai in this example) via word clock. For the 24Ai clock source, choose any source besides word clock, as it is not advisable to chain word clock.



Figure 4-9: Slaving your MOTU device (a 24Ai in this example) to word clock. For the 24Ai clock source, choose 'Word Clock In'.

Follow system clock / Force 1x clock

When operating the 24Ai or 24Ao at high sample rates (88.2 kHz or higher), the Word Clock Out can either match the interface's operational sample rate or its corresponding 1x sample rate. For example, if the 24Ao is operating at 192kHz, you can choose to generate a word out rate of 48kHz using the *Force 1x Clock* setting in the Device tab of the MOTU AVB Control web app (item #15 on page 14).

Word clock is not needed for AVB networking

When working with multiple MOTU AVB interfaces on an AVB network, synchronization is handled by AVB, so no word clock connections are necessary. See the next section for details.

SYNCING AN AVB NETWORK

The AVB protocol provides sophisticated and accurate timing, synchronization, and clocking features for AVB device networks of any size as shown on pages 35-36, including:

- Low latency
- Network-wide time base
- Better-than-sample-accurate phase lock across all connected devices
- Timing accuracy down to the nanosecond

Choosing a master clock

The web app provides an easy way to choose one device as the master clock for your whole MOTU AVB network.

- 1 Go to the Devices tab (page 14).

- 2 In the device list (item #1 on page 14), choose the MOTU interface you wish to use as the clock master.

- 3 Click the *Become Clock Master* button below the Clock Mode menu.

Now, all other MOTU AVB devices on the network are resolved to this device.

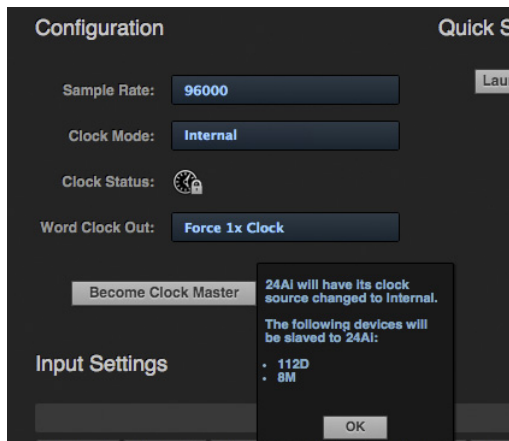

Figure 4-10: Choosing a clock master.

Alternately, you can go to the clock mode menu for each individual device separately and choose the master clock device by hand. For example, you may be in a situation where at least one MOTU device on the network must remain resolved to its own clock (or another clock source). Just know that in this case, audio cannot be streamed between MOTU AVB devices that don't share the same master clock.

Resolving the master clock device to an external clock source

The MOTU device you've specified as the AVB network clock master can itself be resolved to an external time base such as word clock or optical. Just choose the desired clock source from its *Clock Mode* menu (in the Device tab). Doing so effectively resolves the entire AVB network to the external clock source.

SYNCING MULTIPLE AVB AUDIO INTERFACES CONNECTED TO A MAC

There are several options for clocking multiple AVB audio devices connected to the Mac:

- You can resolve them to an external clock source (like word clock, if available).
- You can create an aggregate device, as usual. The aggregate device setup panel has a check box called *Drift Correction*, which sample-rate converts devices that are not synchronized.

Part 2

*Using your
MOTU interface*

CHAPTER 5 Presets

OVERVIEW

Because of its advanced, extensive feature set, your MOTU AVB interface can be used for many different purposes. This chapter discusses common use cases and their corresponding device presets, to help you use the hardware for your needs.

Preset menu

The preset menu (item #7 on page 14) contains a number of presets specifically designed for common use cases. By loading the corresponding preset, your MOTU AVB interface routing tab and mixer will be reconfigured accordingly. You can visit the Routing and Mixing tabs to inspect settings and adjust them as needed.

Audio interface	47
Stand-alone mixer	48
Interface + mixer.....	48
Live recording with monitor mixing	49
Stage I/O.....	49
Studio Input expander.....	50
Studio Output expander.....	50
Optical converter	51

Create your own presets

You can create presets to suit your specific needs. Your MOTU device is highly capable and configurable, allowing it to perform many tasks simultaneously.

Video tutorials

To view several excellent video tutorials for the presets described in this chapter, visit:

www.motu.com/avb

AUDIO INTERFACE

Choose the *Audio Interface* preset to use your MOTU AVB device as a standard USB audio interface. Hardware inputs and outputs are accessible from your computer, and the mixer and audio networking features are disabled.



Figure 5-1: Using your MOTU AVB device as an audio interface.

STAND-ALONE MIXER

Choose the *Stand-alone* mixer preset to use your MOTU AVB device as a mixer. Doing so routes all physical inputs to the mixer with the mixer main out and monitor out going to two hardware output pairs.

To control the mixer (with the AVB Control web app), you have several options. You can connect a computer to your MOTU AVB device using USB, Ethernet, or Wi-Fi, as explained in “Setup for web app control” on page 38. Figure 5-2 below shows the WiFi scenario. Note that you can control the mix from multiple WiFi devices.

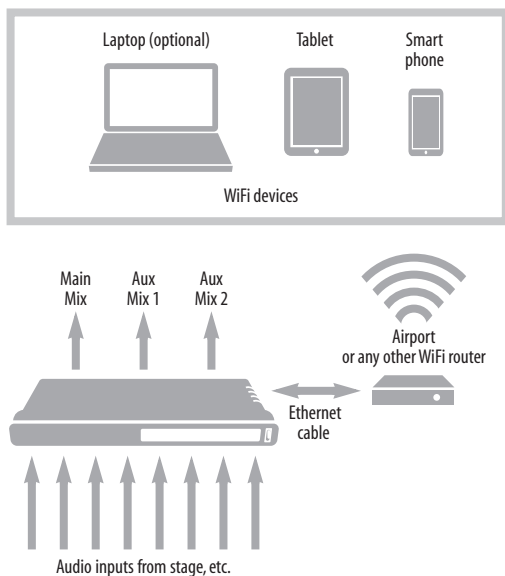

Figure 5-2: Using your MOTU AVB device as a stand-alone mixer. This example demonstrates how you can control the mixer from several Wi-Fi devices.

INTERFACE + MIXER

Choose the *Interface + Mixer* preset to use your MOTU AVB device as both an audio interface and mixer, simultaneously. Doing so routes all physical inputs and outputs to and from the computer, connected through USB. In addition, all MOTU AVB device inputs are routed to the mixer, which mixes them to the Main Mix bus. The Monitor bus is set up as a solo bus.

Specifically for the 24Ai, the internal DSP mixes the analog inputs with eight output channels from the computer. The computer receives analog inputs and the output of the internal mixer.

Specifically for the 24Ao, the internal DSP mixes the ADAT inputs with 8 output channels from the computer. The computer receives ADAT inputs and the output of the internal mixer.

In this scenario, you can control the mixer from the MOTU AVB Control web app running on the computer. You can also run the web app from wireless devices on the same WiFi network as the laptop.

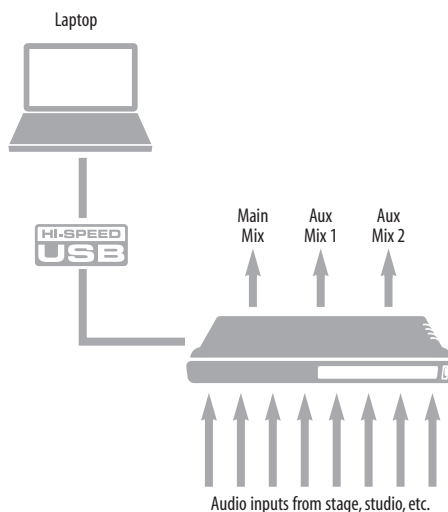

Figure 5-3: Using your MOTU AVB device as an audio interface and mixer, simultaneously.

LIVE RECORDING WITH MONITOR MIXING

Choose the *Live recording with monitor mixing* preset when you are tracking in the studio. The setup is pretty much the same as for the “Interface + mixer” preset discussed in the previous section, shown in Figure 5-3 on page 48. All physical inputs on the interface are routed to both the computer (for recording) and the Main Mix and Monitor busses in the mixer (for near-zero latency monitoring).

STAGE I/O

Use the *Stage I/O* preset when you want to route audio inputs from musicians and instruments on stage to another location over Ethernet cabling. This preset routes all inputs and outputs on the MOTU AVB interface to 8-channel AVB network streams in the routing grid, which are then broadcast to any/all other devices on the same AVB Ethernet network.

Single AVB Ethernet “snake”

For example, you could have a single Ethernet cable running from a 24Ai on stage to a 24Ao at the Front of House (FOH) mixer.

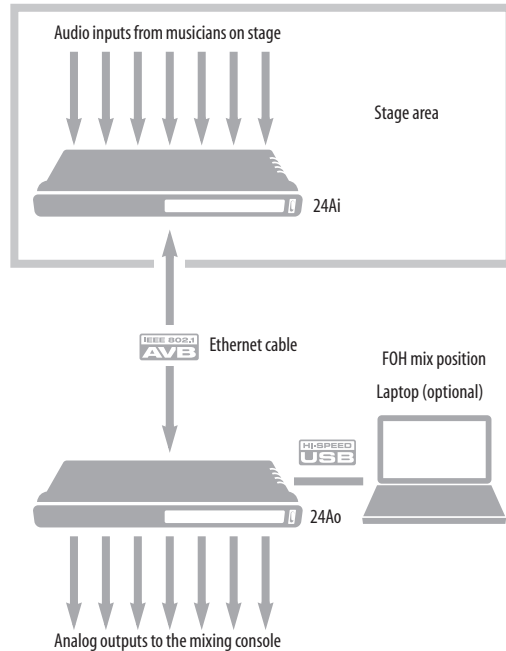

Figure 5-4: An example of using the *Stage I/O* preset. 24Ai analog inputs are routed to network streams. Those streams are carried over the network cable to the 24Ao, which streams them to its analog outputs going to the mixing console. The computer rig is optional and can be used for backup recording of the performance.

Stage I/O to network

As another example, you could run an Ethernet cable from the stage unit to a MOTU AVB Switch, with a host of other MOTU AVB interfaces and computers on a multi-device network.

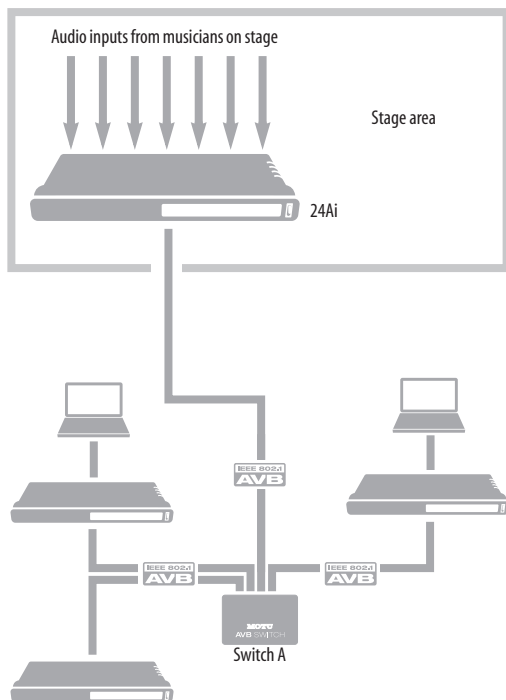

Figure 5-5: Use the Stage I/O preset to connect audio inputs and outputs to other AVB devices on the rest of the network.

STUDIO INPUT EXPANDER

Use the *Studio Input Expander* preset when you already have a main system set up, but you want to add additional inputs. This preset routes all physical inputs (analog and digital) on the expansion MOTU AVB interface to AVB network streams. You can connect to these expansion streams in AVB Stream Connections section of the Device tab of the main MOTU AVB interface.

STUDIO OUTPUT EXPANDER

Use the *Studio Output Expander* preset when you already have a main system set up, but you want to add additional outputs. This preset routes AVB network streams to all physical outputs (analog and digital) on the expansion MOTU AVB interface. You must choose which network streams are used in the AVB Stream Connections section of the Device tab of the expansion MOTU AVB interface.

OPTICAL CONVERTER

Choose the Optical converter preset if you would like your MOTU AVB device to serve as a multi-channel analog-to-digital or digital-to-analog converter connected to another device equipped with an ADAT optical port.

For example, if you have a 24Ai, you could connect the 24Ai optical output to the optical input on another device. The 24Ai then serves as a multi-channel expander that adds an additional 24 analog inputs to your setup. The benefit of connecting the 24Ai optically is that you can seamlessly integrate its inputs into the other device, such as the on-board no-latency CueMix mixing environment in MOTU mk3 interfaces.

Similarly, if you have a 24Ao, you could connect the 24Ao optical inputs to the optical outputs on another device. The 24Ao then serves as a multi-channel expander that adds an additional 24 analog outputs to your setup.

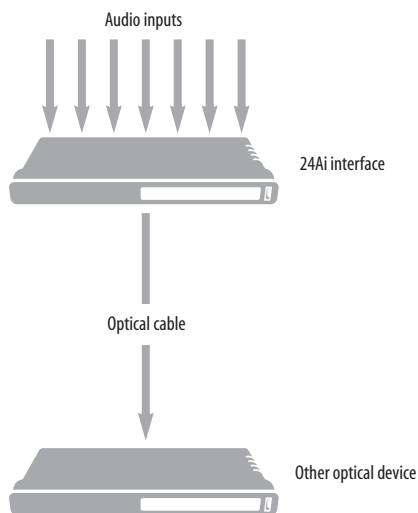

Figure 5-6: Use the Optical converter preset to connect additional audio inputs and outputs to another optical device. This example shows 24Ai interface analog inputs being routed to the other optical device, but you could also do the same thing for outputs, even simultaneously.

CHAPTER 6 The Front Panel LCD

OVERVIEW

The front panel LCD displays level meters for all inputs and outputs. The LCD also provides several navigable menus that provide status information and basic hardware settings.

Level meters	53
ID button	53
Menu Navigation	53
Device menu.....	54
Network menu.....	54
Settings menu	54
Presets menu	54
Version menu.....	54
Clock.....	54
ADAT SMUX Type	54
Stand-alone operation.....	54

LEVEL METERS

In its default state when the unit is first powered on, the LCD displays level meter activity for all physical audio inputs and outputs on the device.

The meters display from -42dBFS to 0dBFS, as shown by the labels to the left of the LCD display (Figure 6-1).

ID BUTTON

Push ID (Figure 6-1) to immediately view the device's network information, including its IP Address. Push back to return to the meters.



Figure 6-1: Buttons on the 24Ai and 24Ao front panel.

MENU NAVIGATION

Push SEL (select) to access the main menu, which provides settings and status information.

Main Menu

Push the up/down arrow buttons to scroll through the menu settings on the left side of the LCD.

Push SEL to enter the selected sub-menu (column of options to the right) or to select the currently highlighted parameter.

Push BACK to go to the parent menu.

To exit the menu entirely, push BACK repeatedly until the menu disappears from the display.

Device menu

The Device menu provides information about the device, such as its name and connection mode (USB or AVB).

Network menu

The Network menu displays the following network-related information:

Setting	Explanation
Serial/UID	Unique AVB network identifier that can be used for troubleshooting.
IP address	The unique network address for the unit. Type this address into your web browser to access the unit's settings in the MOTU AVB Control web app.
AVB	Indicates whether AVB networking is currently enabled or disabled. For example, AVB could be disabled because a non-AVB switch is being used. When AVB is disabled, audio streaming over the network is disabled.

Settings menu

The Settings menu provides access to basic hardware settings, such as Clock Mode, Sample Rate, and so on.

Setting	What it does
Clock Mode	Sets the digital audio clock source for the device.
Sample Rate	Sets the sample rate for the device.
Word Clock Thru Mode	Toggles the Word Clock Output between OUT and THRU.
Optical	Specifies the SMUX format when operating at 88.2 or 96 kHz. See “ADAT SMUX Type” on page 54.
Configure IP	Chooses between DHCP and a manually assigned IP Address.
LCD Contrast	Adjusts the contrast of the LCD.
Factory Defaults	Restores factory default settings.

Presets menu

The Presets menu lets you recall settings that have been saved as a *device preset*. Use the web app to create and save presets (item #7 in the “Device tab” on page 14).

Version menu

The Version menu displays firmware version information.

CLOCK

The Clock section of the LCD displays the sample rate at which the unit is currently operating, and the current Clock Mode setting (item #13 in the Devices tab on page 14). The Clock Mode setting can also be found (and changed) in the Settings Menu.

ADAT SMUX TYPE

When your MOTU interface is operating at either 88.2 or 96 kHz, the *Settings menu > Optical* setting lets you configure ADAT SMUX type. There are two choices:

- Type I — interoperation with 3rd-party SMUX-compatible hardware products
- Type II — interoperation with compatible MOTU products

STAND-ALONE OPERATION

All settings, including mix settings and device settings, are saved in your MOTU interface's memory. They remain in effect even when the interface is not connected to a computer. This allows you to use your MOTU device as a stand-alone mixer. You can make adjustments to any setting at any time from the web app running on a device that has a network connection to your MOTU interface, as explained in “Setup for web app control” on page 38.

CHAPTER 7 Working with Host Audio Software

OVERVIEW

Your MOTU interface provides multi-channel audio input and output for Core Audio compatible audio applications on the Mac and ASIO or Wave compatible applications on Windows, including MOTU's Digital Performer and AudioDesk, Apple's Logic Pro and GarageBand, and other third-party software applications such as Ableton Live, Avid Pro Tools, Cockos Reaper, Propellerhead Reason and Record, Steinberg Cubase and Nuendo, Cakewalk SONAR, PreSonus Studio One, Bitwig, and others.

AudioDesk is available as a free download for 24Ai and 24Ao owners at motu.com/avb. For complete information about all of AudioDesk's powerful workstation features, refer to the *AudioDesk User Guide.pdf* included in the AudioDesk application.

Digital Performer, MOTU's state-of-the-art digital audio workstation software, is available separately; for details about upgrading from AudioDesk to Digital Performer, talk to your authorized MOTU dealer or visit motu.com.

Preparation	55
Run the web app.....	55
Choosing the MOTU Audio driver.....	58
Reducing monitoring latency.....	59
Working with on-board mixing and effects.....	61
Synchronization	61

PREPARATION

Install your host audio software first if you haven't already done so, and complete these chapters before proceeding:

- chapter 3, "Software Installation" (page 29)
- chapter 4, "Hardware Installation" (page 33)

RUN THE WEB APP

Before you run your host audio software, launch the web app to configure your MOTU hardware.

The web app lets you configure important settings in your audio interface, enable the desired inputs and outputs, and set up audio streams to and from the computer.

Sample rate

Choose the desired sample rate for your interface and your host audio software. Newly recorded audio will have this sample rate.

Clock Mode

This setting is important because it determines the master digital audio clock for your system.

If you do not have any digital audio connections to your MOTU device (you are using the analog inputs and outputs only), and you will not be resolving your host software to word clock or another external clock source, choose *Internal*.

If you have devices connected to the optical ports, see "Syncing optical devices" on page 41.

If you are slaving your MOTU device and your host software to word clock, follow the directions in "Syncing word clock devices" on page 41.

Enabling and disabling input/output banks

In the web app Device tab (page 15), enable all input and output banks on your MOTU device that you wish to make available to your host audio software. Disable banks you are not using to simplify operation.

Specifying the number of computer channels

In the web app Device tab (page 15), in the *Computer Setup* section, specify the number of computer channels for streaming audio to and from your host audio software. You might want enough channels to cover the following:

- Physical inputs you want to record on your computer.
- The physical outputs you want to send audio playback to.
- Any audio streams going to and from the on-board mixer in your MOTU device
- Any audio streams going to and from the AVB network, if you have multiple networked MOTU AVB devices

If you aren't sure how many channels you'll need, visit the Routing tab, as explained below.

Making inputs and outputs available to your host software

In the web app, use the Routing tab (page 16) to map inputs and outputs to computer channels, as demonstrated in Figure 7-1 and Figure 7-2.

Configuration presets

The presets menu (item #7 in the Devices tab on page 14) provides many useful presets for various host routing scenarios. These presets are a convenient shortcut for the routing grid setups discussed in the next few sections.

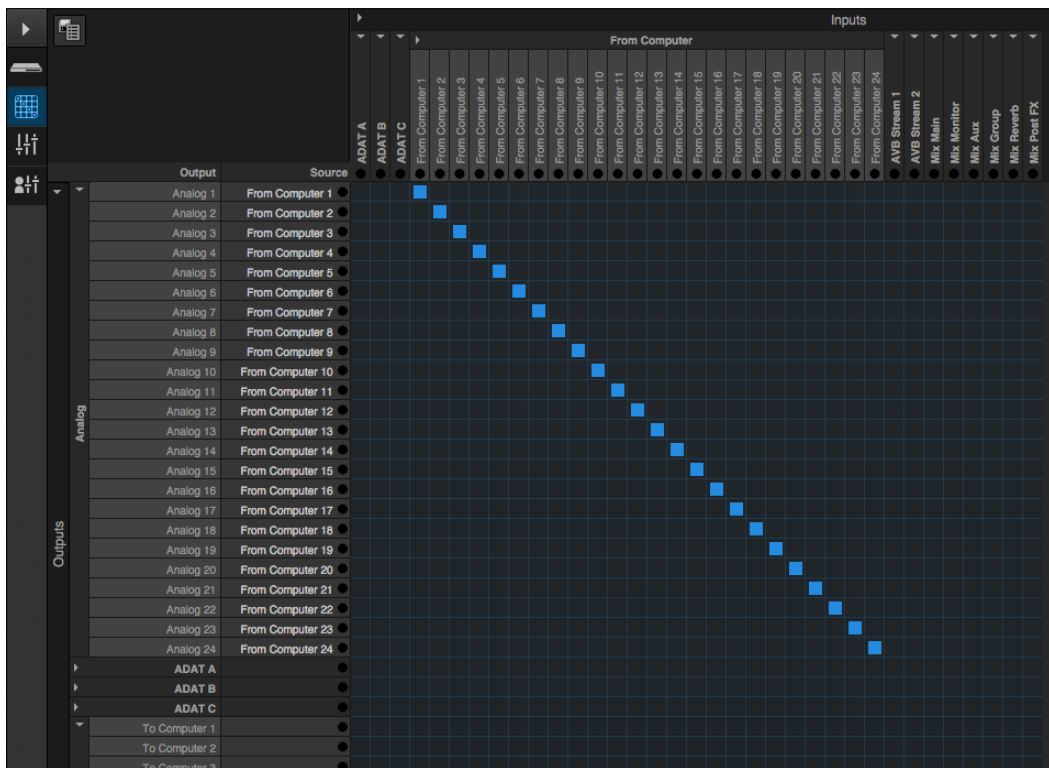

Figure 7-1: An example of routing computer channels (from host audio software) to the analog outputs on a 24Ao.

Naming computer input and output channels
Click on any computer input or output name in the routing grid (Figure 7-1) to change its name.

Streaming computer audio to and from the on-board mixer
In Figure 7-1, you'll see “mix” inputs across the top of the grid (Main, Monitor, Aux, etc.) These are output busses from the your interface’s on-board mixer. To route one of these mix busses to your host computer software, click the grid at the intersection of the computer channel column and the desired mix input row. Now, that computer channel will be routed to the mixer input.

computer channel row. Now, the mix bus output will be routed to the computer via the channel you selected.

Conversely, you can stream audio from the computer into the mixer. Channels coming from the computer are represented across the top of the routing grid as inputs. To route a computer channel to the mixer, click the grid at the intersection of the computer channel column and the desired mix input row. Now, that computer channel will be routed to the mixer input.

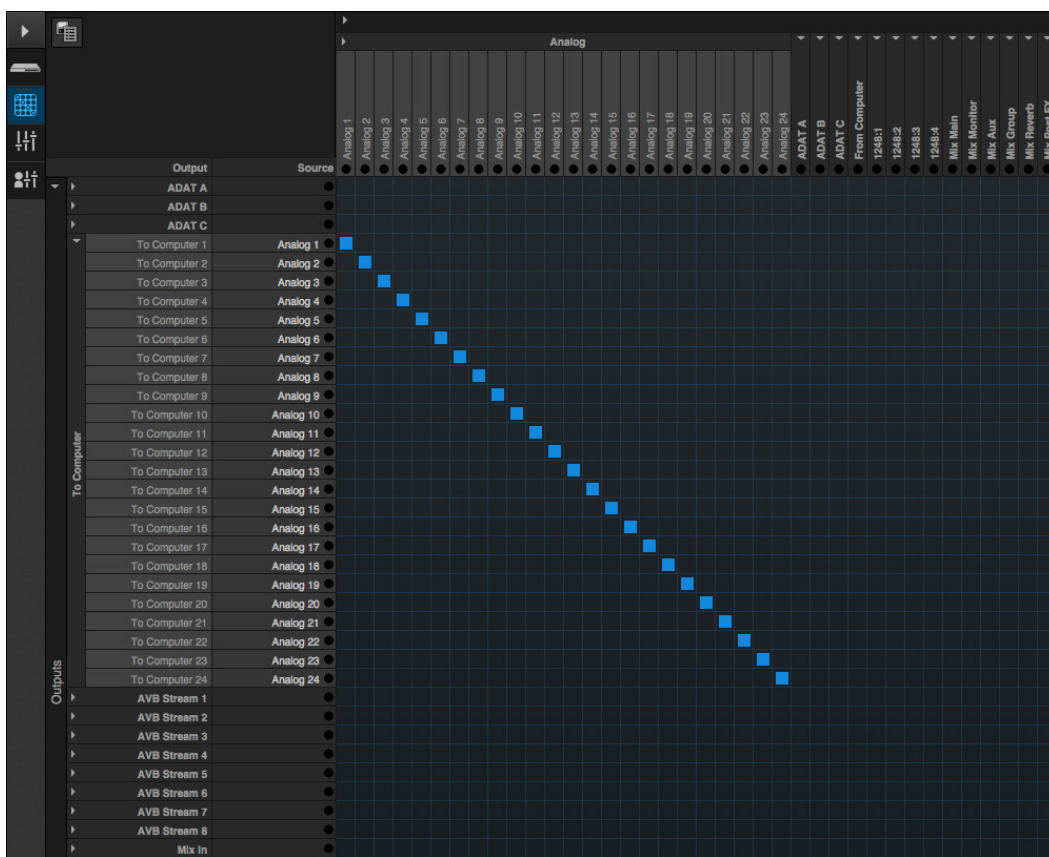

Figure 7-2: An example of routing physical inputs on the 24Ai to computer channels (for host audio software).

Working with AVB network streams

Audio channels going to networked AVB interfaces can be streamed to and from your host audio software through the MOTU interface connected directly to the computer. For information about how to set this up, see “Mapping computer channels to network streams” on page 73.

Mirroring computer channels to multiple outputs

Figure 7-1 shows an example of mirroring one stereo audio stream from your host audio software to several outputs. In the example, computer channels 1-2 are being sent to the main outs, plus phones 1-2 and phones 3-4. To route an input to multiple outputs, click multiple boxes in its column, (see computer channels 1-2 in Figure 7-1).

Combining multiple inputs to one output

To merge (mix) any channels in the grid (computer streams or otherwise), route them to mixer inputs and then use the on-board mixer (“Mixing tab” on page 17).

Routing grid tutorials

For further information about using the routing grid, including many useful tips and techniques, visit:

www.motu.com/techsupport/technotes/avbrouting

CHOOSING THE MOTU AUDIO DRIVER

Once you’ve made the preparations described so far in this chapter, you’re ready to run your audio software and enable the MOTU AVB audio driver, which allows your host software to use the the 24Ai or 24Ao as an audio interface.

For Mac OS X audio software

For audio software running under Mac OS X, go to the menu item or preference where you choose the audio device (Core Audio driver) you wish to use, and then select the the 24Ai or 24Ao by name.

For Windows audio software

For audio software running under Windows, go to the menu item or preference where you choose the ASIO driver you wish to use, and then choose *MOTU AVB USB ASIO*. If your host audio software doesn’t support ASIO, choose the *MOTU AVB USB AUDIO Wave* driver instead.

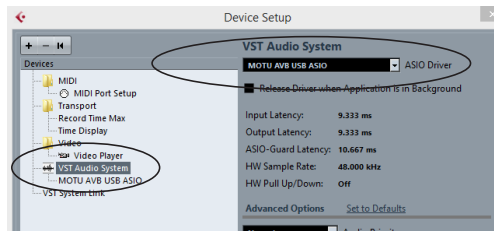

Figure 7-3: Choosing the MOTU AVB ASIO driver in Cubase.

Where to go in popular audio hosts

Here is the location for this setting in various popular audio software host applications:

Host software	Location for choosing the the 24Ai or 24Ao
Digital Performer and AudioDesk	Setup menu > Configure Audio System > Configure Hardware Driver
Pro Tools 9 or later	Setup menu > Playback Engine or Current Engine
Logic Pro	Preferences > Audio tab > Devices tab > Core Audio tab
Garage Band	Garage Band menu > Preferences > Audio/MIDI > Audio Output/Input menus
Cubase and Nuendo	Device Setup > Devices list > VST Audio System menu
Live	Preferences > Audio tab
Reason	Preferences > Audio preferences
Reaper	Preferences > Audio prefs > Devices

Other audio software

Consult your software’s manual for further information.

REDUCING MONITORING LATENCY

Monitoring latency is a slight delay caused by running an input signal through your host audio software and back out. For example, you might hear it when you drive a live guitar input signal through an amp modeling plug-in running in your audio sequencer.

This delay is caused by the amount of time it takes for audio to make the entire round trip through your computer, from when it first enters an input on your MOTU interface, passes through the interface hardware into the computer, through your host audio software, and then back out to an output.

Monitoring through your MOTU interface

If you don't need to process a live input with plug-ins, the easiest way to avoid monitoring latency is to disable your DAW's live monitoring feature and instead use the digital mixer in your MOTU interface to route the input directly to your outputs. For details, see "Mixing tab" on page 17. The mixer in your MOTU interface even provides zero latency effects processing (EQ, compression and reverb), which can be applied to the signal.

Direct hardware playthrough / Direct ASIO monitoring

When managing your live monitor mix through your MOTU interface mixer, remember to disable your DAW's live monitoring features, so that you won't hear record-enabled tracks in your DAW. Also note that your MOTU AVB interface does not support *Direct Hardware Playthrough* in Digital Performer, or the *Direct ASIO Monitoring* feature (or similar) offered and other DAWs, which lets you control no-latency hardware monitoring from within the host application. Instead, you can use the MOTU AVB Control web app mixer ("Mixing tab" on page 17) to make these live monitoring connections manually.

If you don't require any effects processing on the input signal (no reverb or compression, for example), all this takes is one click in the routing grid to route the input being recorded to the output you are using for monitoring.

If you are recording a mono input that you'd like to monitor in stereo, or if you need to apply effects to the monitored signal, you can simply route the input to the mixer in your MOTU interface. This is done by opening the *Mix In* group in the *Outputs* column along the left side of the grid (Figure 7-2 on page 57), and clicking the tile at the intersection of the input's column and the desired mixer input's row. Once routed to the mixer, use the input channel, reverb bus, and monitor bus in the mixer to apply effects as desired, and perhaps include other channels to the mix, and then assign the monitor bus output in the routing grid to the output you are using for monitoring.

In either case (routing directly in the grid or routing through the mixer), be sure to maintain the input's connection to the computer as well, so the input signal can be recorded in your host software. In other words, you'll want to make sure there are two tiles enabled in the input's column in the grid: one tile for the connection to the computer and another tile for your monitoring output (or a mixer input, if you are using the mixer to apply effects). If you need to route the input signal to other destinations, too, you can certainly do so (you can route the input to multiple destinations).

Monitoring through your host audio software

If you *do* need to process a live input with host software plug-ins, or if you are playing virtual instruments live through your MOTU audio hardware, you can significantly reduce latency by adjusting the audio buffer setting in your host audio software, as explained in the next section.

It is important to note that monitoring delay has no effect on the recording, or playback, of audio data from disk. The actual recording and playback is extremely precise, it is only the monitoring of your live input signal which may be delayed.

Adjusting your host software audio buffer

Buffers are small bundles of audio data. Your interface “speaks” to your computer in buffers, rather than one sample at a time. The size of these buffers determine how much delay you hear when monitoring live inputs through your audio software: larger buffers produce more delay; smaller buffers produce less.

Adjusting buffer size on Mac OS X

Under Mac OS X, audio I/O buffer size is handled by the host audio application (not by your MOTU interface’s Core Audio driver). Most audio software applications provide an adjustable audio buffer setting that lets you control the amount of delay you’ll hear when monitoring live inputs or processing them with software plug-ins. Here are a few examples.

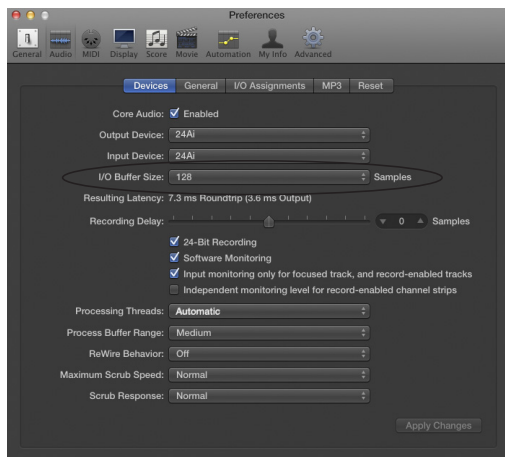

Figure 7-4: In Logic Pro, go to the Audio Driver preferences to access the Buffer Size option shown above.

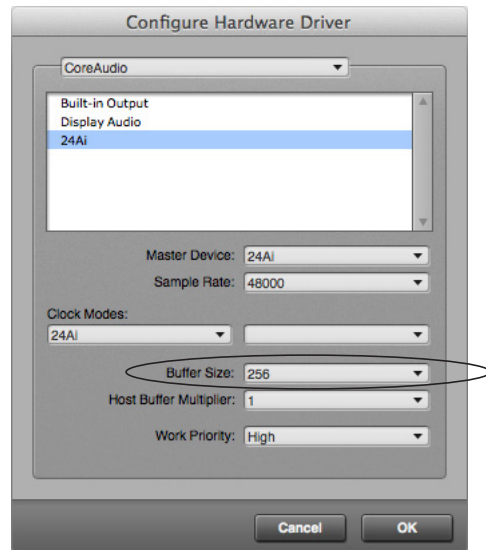

Figure 7-5: In Digital Performer and AudioDesk, choose Setup menu > Configure Audio System > Configure Hardware Driver to open the dialog shown above and access the Buffer Size setting. Refer to your Digital Performer or AudioDesk manual for information about the Host Buffer Multiplier setting.

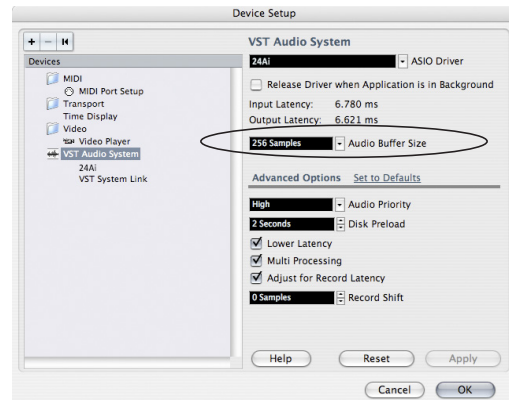

Figure 7-6: In Cubase or Nuendo, choose Devices menu > Device Setup. Select your interface (24Ai or 24Ao), then click the Control Panel button to access the window above and the Buffer Size setting.

Adjusting buffer size on Windows

To adjust buffer size on Windows, visit the MOTU AVB USB Control Panel. See “MOTU AVB USB Control Panel” on page 30.

Lower latency versus higher CPU overhead

Buffer size has a large impact on the following:

- Monitoring latency
- The load on your computer's CPU
- Responsiveness of transport controls and effect knobs in AudioDesk, Digital Performer or other audio software.
- Real-time virtual instrument latency.

The buffer setting presents you with a trade-off between the processing power of your computer and the delay of live audio as it is being patched through your software. If you reduce the size, you reduce monitoring latency, but significantly increase the overall processing load on your computer, leaving less CPU bandwidth for things like real-time effects processing. On the other hand, if you increase the buffer size, you reduce the load on your computer, freeing up bandwidth for effects, mixing and other real-time operations.

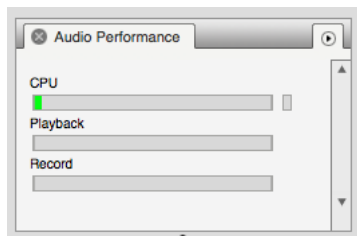

Figure 7-7: When adjusting the buffer size to reduce monitoring latency, watch the 'processor' meter in Digital Performer or AudioDesk's Performance Monitor. If you hear distortion, or if the Performance meter is peaking, try raising the buffer size.

If you are at a point in your recording project where you are not currently working with live, patched-thru material (e.g. you're not recording vocals), or if you have a way of externally processing inputs, choose a higher buffer size. Depending on your computer's CPU speed, you might find that settings in the middle work best (256 to 1024).

Transport responsiveness

Buffer size also impacts how quickly your audio software will respond when you begin playback, although not by amounts that are very noticeable. Lowering the buffer size will make your software respond faster; raising the buffer size will make it a little bit slower.

Effects processing and automated mixing

Reducing latency with the buffer size setting has another benefit: it lets you route live inputs through the real-time effects processing and mix automation of your audio software.

WORKING WITH ON-BOARD MIXING AND EFFECTS

Your MOTU interface provides powerful mixing, EQ, compression and reverb, which can operate hand-in-hand with your host's mixing environment. For example, your MOTU interface can serve as a monitor mixer, routing channels to musicians, or it can serve as an integrated extension of your host's mixing environment. You can even save a particular mixing configuration as a preset for future recall. For details, see "Mixing tab" on page 17.

SYNCHRONIZATION

You may encounter situations in which you need to synchronize your audio software and your MOTU interface to other components of your system. For details, see "Synchronization" on page 40.

CHAPTER 8 Mixer Effects

OVERVIEW

This chapter provides further information about the effects processors available in the DSP mixer in your MOTU AVB interface. For basic mixer operation, see:

- Mixing tab 17
- Aux Mixing tab 18
- Mixer input channel strips 19
- Main Mix and Monitor channel strips 20
- Aux bus channel strips 21
- Group and Reverb channel strips 22

Powerful DSP-driven mixing and effects

The mixer is driven by a powerful DSP that delivers 32-bit floating point precision and plenty of processing bandwidth for no-latency effects, including parametric EQ, dynamics, and reverb. Effects can be applied when operating as an audio interface or as a stand-alone mixer without a computer. Input signals to the computer can be recorded wet and/or dry, or recorded dry while a real-time wet monitor mix is sent to musicians. Effects include:

- High Pass Filter 63
A conventional high pass filter
- Gate 64
A standard gate with threshold/attack/release controls
- Four-band parametric EQ 64
Multi-band parametric EQ modeled after British analog consoles
- Compressor 65
A standard compressor with threshold/ratio/attack/release/gain controls

- Leveler 66

The Leveler™, an accurate model of the legendary LA-2A optical compressor, which provides vintage, musical automatic gain control

- Reverb 67

Classic reverb with tail lengths up to 60 seconds

Advantages over host-based mixing and processing

The hardware mixer in your MOTU AVB interface provides several major advantages over mixing and processing in your host audio software:

- No buffer latency. The DSP-mixer provides the same near-zero latency throughput performance as a conventional digital mixer. Effects processing doesn't impact your computer's CPU.
 - DSP mixing and routing can be maintained independently of individual software applications or projects.
 - DSP-driven mixing can function without the computer, allowing your MOTU AVB device to operate as a portable, stand-alone mixer with effects.
- ☛ Effects are disabled when operating at 4x sample rates (176.4 or 192 kHz).

HIGH PASS FILTER

All input channel strips provide a 12 dB per octave high pass filter. High Pass filters are often used to remove unwanted mic rumble, for example.

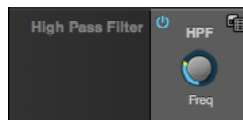

Figure 8-1: The High Pass Filter.

GATE

All input channel strips provide a Gate module.



Figure 8-2: The Gate module.

The gate silences the signal when the input signal's level drops below the *Threshold*.

The rate at which the gate responds, (opens to let signal through) is determined by the *Attack* parameter. With a short Attack time, the gate will open as soon as the signal crosses the Threshold; with longer Attack times, the gate will gradually open, much like a fade-in.

When the input level falls back below the Threshold, the time it takes for the gate to close (how quickly the signal is attenuated), is determined by the *Release* parameter. Short Release times will close the gate quickly, abruptly attenuating your signal, versus longer release times, which will gradually attenuate your signal, like a natural fade-out.

FOUR-BAND PARAMETRIC EQ

All mixer channel strips, (except for the Monitor bus), provide modeled, four-band parametric EQ.

Vintage EQ

Inspired by legendary British large console EQs, the *EQ section* (Figure 8-3) models the sound of the most sought-after classic equalizers. Four bands of center frequency parametric EQ filtering are provided, each with a bandwidth control. The High and Low bands include a shelf filtering option. With 32-bit floating point precision, the vintage EQ has been carefully crafted and meticulously engineered to produce musical results in a wide variety of applications.

Enabling EQ

Each band has an *enable/disable* button (Figure 8-3), allowing you to enable as few or as many bands as needed for the channel strip.

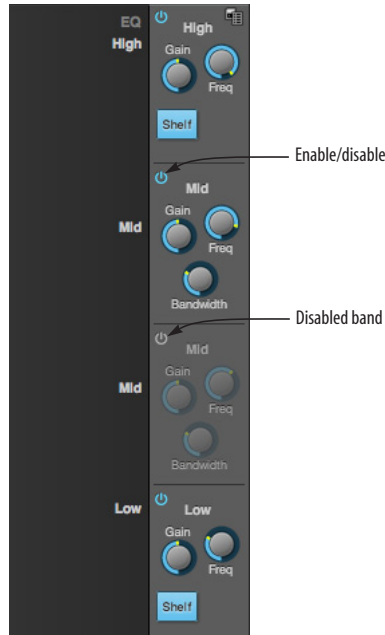

Figure 8-3: The Four-band parametric EQ module.

EQ filter controls

The EQ filters have three controls:

Control	unit	range
Gain	dB	-20.00 to +20.00
Frequency	Hertz	20 to 20,000
Bandwidth	Octaves	0.01 to 3.00

Double-click a knob to return to its default position.

EQ filter characteristics

EQ is one of the most widely used processing tools and can be applied to many different situations, from minor corrective tasks to creative tone sculpting. The four-band EQ has been designed to

be flexible enough to cover a broad range of applications. By adjusting Gain and Bandwidth together, you can emulate the smooth and musical character of classic analog EQ circuits, in which the Gain/Bandwidth dependency was dictated by the actual circuit design and electrical components used.

Low and high shelf filters

The Low and High bands offer a shelf option that is similar to those found in most conventional parametric EQs.

COMPRESSOR

All mixer input channel strips provide a compressor module.



Figure 8-4: The Compressor module.

The *Compressor* (Figure 8-4) lowers the level of the input when amplitude of the signal is above the Threshold. The amount of attenuation is determined by the *Ratio* and the input level. For example, if the input is 6 dB above the *Threshold* and the *Ratio* is 3:1, the compressor will attenuate the signal to 2 dB above the Threshold. When the input level goes above the threshold, the attenuation is added gradually to reduce distortion. The rate at which the attenuation is added is determined by the *Attack* parameter. Likewise, when the input level falls below the Threshold, the attenuation is removed gradually. The rate at which the attenuation is removed is determined by the *Release* parameter. Long Release times may cause the audio to drop out briefly when a soft passage

follows a loud passage. Short Release times may cause the attenuation to “pump”, a term used to describe the sound of the compressor when the average input level quickly fluctuates above and below the Threshold. These types of issues can be addressed by adjusting the compressor’s parameters, or applying the Leveler instead. *Gain* adjusts the overall output level of the compressor, post processing. The Level meter (Figure 8-4) shows the level of the input signal entering the compressor. It shows either the Peak envelope or the RMS level, if enabled.

Gain reduction meter

The Gain reduction meter (Figure 8-4) displays the current amount of attenuation applied by the compressor, before the makeup gain stage.

RMS mode

By default, the compressor operates in Peak mode, which uses signal peaks to determine the input level. In RMS mode, the compressor measures the input signal’s loudness, using the root-mean-square computational method. When RMS is disabled, RMS mode will let brief peaks through because the detector sidechain is only looking at the average signal level. By contrast, peak mode will catch those brief peaks. Peak mode is generally used for drums, percussion and other source material with strong transients, while RMS mode is mostly used for everything else.

The level meter shows either the peak level or the RMS level, depending on the mode.

LEVELER

The Leveler™ (Figure 8-5) provides an accurate model of the legendary Teletronix™ LA-2A® optical compressor, known for its unique and highly sought-after Automatic Gain Control (AGC) characteristics.



Figure 8-5: The Leveler module.

The Leveler is available on the Main Mix bus and all Group busses, including the Reverb bus.

A model of an optical compressor

An optical leveling amplifier works by shining a light on a photoresistor. The intensity of the light source is proportional to the audio signal, and the resistance of the photoresistor is in turn inversely proportional to the intensity of the light. Photoresistors respond quite quickly to increases in light intensity, yet return to their dark resistance very slowly. Thus, incorporation of the photoresistor into an attenuator followed by an amplifier which provides make-up gain produces a signal which maintains a constant overall loudness.

Automatic gain control using light

The AGC circuit of the LA-2A uses a vintage optocoupler known by its model number T4. The T4 contains an electroluminescent-panel (ELP) and photoresistor mounted so that the emission of the panel modulates the resistance. An ELP consists of a thin layer of phosphorescent material sandwiched between two insulated electrodes to

form a capacitor. Making one of the electrodes transparent allows the light to escape. These devices are essentially glow-in-the-dark paint on a piece of foil covered by metalized glass or plastic, and are the same devices used in low-power night lights. Unfortunately, these devices need high voltages to operate, and are best driven by tube circuits which can supply voltage swings of several hundred volts.

Response characteristics

Once the light has faded away, the photoresistor then decays back to its dark state. The shape of the decay curve varies depending on how bright the light was, and how long the light lasted. A general rule of thumb is that the louder the program, the slower the release. Typically, the release can take up to and over one minute. One thing to keep in mind when using these types of devices is that the typical concepts of compression ratio, attack, release, and threshold do not apply. The light intensity is determined by the highly non-linear interactions of the input signal, AGC circuit, and ELP, and thus exhibit a strong program dependence that is impossible to describe without the mind-numbing mathematics of statistical mechanics. The actual results, however, can be almost mystical: even when you feed the same material (a loop perhaps) through the Leveler twice, you'll often see a new response the second time through a loop, complete with unique attack times, release times and compression ratios. Furthermore, two different input signals with the same RMS levels may be leveled in a drastically different manner.

It is precisely this self-adjusting behavior that makes optical compressors the tool of choice for smoothing out vocals, bass guitar and full-program mixes without destroying perceived dynamics.

Enabling or disabling the Leveler

The Leveler models the LA-2A so closely, it also models the time it takes for an actual LA-2A to “warm up” after it is turned on. Therefore, when you enable the Leveler, give it a moment to “settle” before you begin processing signals with it.

Gain Reduction

Gain Reduction (Figure 8-5) sets the strength of the signal sent to the AGC model.

Makeup Gain

Makeup gain (Figure 8-5) amplifies the output signal to make up for gain reduction.

Limit button

The *Limit* button (Figure 8-5) models the original LA-2A Limit/Compress mode switch. The effect is very subtle, with the Limit option behaving only slightly more like a limiter than a compressor. The switch increases the level of the input to the AGC model and runs the attenuator at a slightly lower level. The Leveler then responds more strongly to transients, but otherwise still behaves like a leveling amplifier.

REVERB

Use the enable/disable button (Figure 8-6) to turn the reverb processor on or off. Since reverb uses considerable DSP resources, it is best to leave it off when you are not using it.



Figure 8-6: The Reverb processor.

Routing inputs and groups to the reverb processor

The reverb processor is a single, independent unit that provides stereo reverb. You can route any input channel or Group bus to the Reverb processor with the Reverb send on its channel strip. All incoming signals to the reverb processor are merged and processed together. The resulting stereo output from the reverb can then be merged into the Main Mix bus with the Main send on the Reverb channel strip (item #6 on page 22).

Reverb Time

Reverb time (Figure 8-6) determines the length of decay, or *tail*, of the reverb. The knob's range is from 100 milliseconds to 60 seconds.

Predelay

Predelay is the amount of time before the acoustic energy from the source returns to the listener, after reflecting off the surfaces of the listening space. The very first reflections helps you perceive information about the listening space, (size, distance, surface type, etc.). In large rooms, it takes a while (on the order of milliseconds) before the first reflections return to the listener. Predelay is useful for adding clarity, as it delays these reflections, before the onset of full reverberation. For example, with pre-delay added to vocals, the reflections won't start until after the initial sound of a word has been sung.

Spread

Spread controls stereo imaging. A position of 12 o'clock produces essentially a mono image. Turning the control all the way to the left completely swaps the stereo image.

High and Mid frequency bands

The High and Mid frequency bands let you independently control the reverb time for separate frequency bands, relative to the low frequency reverb time. The *High* setting represents the bottom frequency of the High band; the *Mid*

setting represents the bottom frequency of the Mid band. The *Ratio* determines the length for each band specified in a percentage of the low frequency reverb time.

DSP USAGE

The DSP Usage meter (item #26 on page 19) shows how much of the available DSP processing power is currently being used by the mixer for the mix and for effects processing. If there aren't enough DSP resources for all effects to be enabled on a channel, effects are disabled for that channel and all subsequent channels.

☛ Unlike other effects, HPF and EQ on a stereo channel requires approximately twice the DSP resources as on a mono channel.

CHAPTER 9 Networking

OVERVIEW

The Audio Video Bridging (AVB) network port on your MOTU interface opens up a world of possibilities for creating expanded, customized audio network systems.

About AVB	69
MOTU's AVB implementation	70
Networking examples	70
A quick guide to networking	72
Setting up a MOTU AVB interface for networking....	73
Mapping audio to network streams	73
Mapping computer channels to network streams ...	73
Bridging to Ethernet	74
The MOTU AVB Switch	74

ABOUT AVB

Audio Video Bridging (AVB) is an extension of the Ethernet standard developed by the IEEE (802.1 standards committee) specifically to add high-performance audio and video networking. AVB brings together the worlds of networking technology and high-end audio. Here is a brief summary of some of the immediate benefits of AVB for you, as a MOTU AVB interface user:

- An open industry standard — AVB has been developed by the IEEE as an international standard specification. It is not proprietary or controlled by one company.
- High channel counts — AVB provides hundreds of network channels.
- Extremely low latency — AVB guarantees low-latency, real-time performance.
- Guaranteed Quality of Service (QoS) — AVB's Stream Reservation Protocol provides Guaranteed Quality of Service for each and every audio stream. If the network cannot continuously maintain every

bit of every sample in the audio stream, it will not allow you to make the network connection in the first place. AVB streams are prioritized over other network traffic to ensure high performance.

- Network-wide clocking and sync — AVB devices all clock together over your network for better-than-sample-accurate phase lock across all connected devices. Timing accuracy is down to the nanosecond.
- True plug-and-play operation — AVB has been designed from the ground up to provide automatic device discovery, enumeration, and connection management. Just plug your MOTU AVB interfaces into a standard AVB switch and go. If you wish to make stream connections and have the ability to select media clock, you must use the web app, or some other AVB controller. You don't need an IT professional to configure the network. AVB is a self-managing network protocol.
- Bridging to standard Ethernet — AVB cooperates with standard Ethernet networks, for connecting traditional Ethernet devices like wireless routers, switches, or any other non-AVB-aware device.
- Support for existing network infrastructure — Replace your existing switches with standard AVB-compatible switches, and your CAT-5e or CAT-6 wired infrastructure now supports AVB.
- Long cable runs — a single AVB network connection can run up to 100 meters with a standard copper wire CAT-5e or CAT-6 cable. Fiber-optic cable runs can be much longer. With multiple switches, you can create a network that covers very large distances, if necessary. You can use up to seven “hops” (switch-to-switch connections).

- AVB is already shipping on current Macs — Apple supports AVB on all current shipping Macs, and the 24Ai and 24Ao can operate as a standard AVB audio interface when connected to your Mac’s AVB-equipped Ethernet port.

MOTU’S AVB IMPLEMENTATION

MOTU engineering has faithfully implemented the IEEE 802.1 AVB standard for the MOTU AVB products. This means that MOTU devices are fully interoperable with any 3rd party AVB-compatible device. In addition, MOTU has fine-tuned AVB operation among MOTU AVB devices for optimum performance, within the AVB specification. Here is a brief summary of advantages you will enjoy when using MOTU AVB devices together in a network:

- 256 channels of host I/O — MOTU AVB interfaces equipped with Thunderbolt (the 1248, 8M, 16A and 112D) support 256 simultaneous channels of audio I/O (128 in, 128 out) to and from the entire network.
- Support for multiple computer hosts — All computers and all network devices run in sync with each other, resolved to the network’s master clock.
- Gigabit Ethernet — The MOTU AVB Switch deliver 1 Gbit Ethernet performance, which provides substantially higher bandwidth than 100 Mbit Ethernet. This allows you to have many more devices on the AVB network.
- Over 500 channels of network audio — MOTU’s AVB network can stream over 500 channels of audio throughout the network. Depending on the model, some MOTU AVB devices can broadcast sixteen 8-channel network streams and simultaneously listen to sixteen 8-channel network streams.

- Exceptionally low network latency — Standard AVB network latency is 2 ms. MOTU AVB network latency is an astonishing 0.6 ms, even over seven “hops” (switches) and hundreds of meters of cable. By comparison, other commercially available, proprietary audio network protocols have variable (unpredictable) network latency in the range of 2-5 ms.

- Star configuration — MOTU AVB supports a star network configuration, which is much more flexible than daisy-chain scenarios, which depends on all devices in the chain.

- Web interface — MOTU AVB devices can be controlled from the MOTU AVB Control web app, which runs within any web browser on any networked laptop, tablet, or smart phone. Although the web app shares the network with AVB, AVB audio streams are never compromised because AVB streams over the network traffic.

- Bridging to standard Ethernet — the MOTU AVB Switch provides an extra standard Ethernet port for bridging to your local Ethernet network, Wi-Fi, etc. for command and control, internet access, and other standard network traffic. All ports allow connection to standard (non-AVB) network devices, however, the “Ethernet” port is suggested because it does not support AVB.

NETWORKING EXAMPLES

Networking comes into play as soon as you hook up a second MOTU interface to your first one, as explained in “Setup for two interfaces” on page 34, to add more I/O to your studio. Here are just a few examples of what is possible.

Personal studio expansion

Let’s say you have a 24Ai mounted in a rack next to your computer. You could add an 8M interface and position it across the room, near your drum kit, for placing up to 8 mics on the drums. All the mic cabling is kept near the drums, and you have one simple, clean network cable running back to your

computer system. Despite the distance, the two interfaces operate as a seamless system, controlled from your computer or iPad.

Studio installation

A studio installation of three to five interfaces can be handled with a single MOTU AVB Switch. See “Setup for three to five interfaces” on page 35.

Networking is ideal for studio installation because you can position interfaces at strategic locations. Running cables becomes much simpler and more cost effective. Not only does a setup like this give you access to all I/O from your computer, even multiple computers, you can also route audio from any input to any output across devices with near zero latency. You can also route audio from one computer to another with very low latency. As a simple example, you could deploy several interfaces in a studio as follows:

Interface	Location	Purpose
24Ao	Control room	Multi-channel output in control room for main monitors, secondary monitors, surround, etc.
1248	Iso booth	Local mic and instrument I/O in the iso booth.
1248	Studio room	General purpose I/O for studio A
8M	Studio room	More mic inputs, or additional mic inputs for drum kit
8M	Studio room drum kit	8 more mics on the drum kit
24Ai	Machine room	Analog inputs for hardware synths, outboard returns, etc.

Large studio facility

In a larger studio facility, you could build audio network neighborhoods similar to the studio installation described earlier in multiple rooms, even multiple floors, with multiple computers and WiFi control from anywhere in the facility. All computers and devices can see each other and you

can stream audio anywhere on the network with near-zero latency, as if any two devices were connected directly to each other.

Concert systems

Concert systems must be flexible so they can adapt to each new venue while on tour. Because of its modular nature, AVB networking allows you to design systems that are scalable and easy to adapt to each venue. You can easily bring devices on and offline, rerouting audio stems as needed.

Because MOTU AVB networking employs a star configuration, instead of daisy-chaining, you can set up backup computer playback systems on a shared network. For example, in a concert setting, if one computer system goes down, the backup system can be brought on line instantly through the same network infrastructure.

Traditionally, live performance setups often have separate domains for front of house mixing, monitor mixing, computer backline, and other systems. With MOTU AVB networking, these systems can be unified on the same network, opening up many possibilities for shared resources and mixing/routing responsibilities, especially from multiple sources (laptops, iPads, tablets, etc.) MOTU AVB networking handles audio in convenient 8-channel stems, making large-scale network management more manageable. MOTU AVB’s very low latency makes it particularly suitable for line arrays and sound reinforcement.

Large-scale venues

With long cable runs and industry standard networking infrastructure, MOTU AVB systems are well-suited for large-scale commercial installations such as arenas, stadiums, theme parks, clubs, casinos, houses of worship, broadcast facilities, schools, universities, and so on. Audio streams can travel long distances with sub-

millisecond latency through as many as seven switches. Audio can be distributed from a centralized location to anywhere in the venue.

A QUICK GUIDE TO NETWORKING

MOTU AVB networking has been designed to be powerful, yet straightforward to set up and use. Here are a few things that are useful to know.

Networking basics

- Before proceeding below, review the networking connection diagrams on pages 34-36.
- When making network connections, use shielded CAT-5e or CAT-6 cables (a higher grade cable).
- Network cable lengths can be long: 100 meters with standard copper wire cables; much longer with fiber-optic network cables.

Working with AVB switches

- Networks of three or more interfaces require an AVB-compatible switch. You can use any standard AVB switch on the market. MOTU offers the five-port MOTU AVB Switch™ (sold separately).

☞ A non-AVB compatible switch will not work.

- Connect MOTU AVB interfaces to any AVB Switch using their NETWORK ports.
- On the MOTU AVB Switch, connect MOTU interfaces to the five AVB NETWORK ports (not the Ethernet port). Connect the Ethernet port to a WiFi router, your Local Area Network (LAN) or your computer (for running web app only).

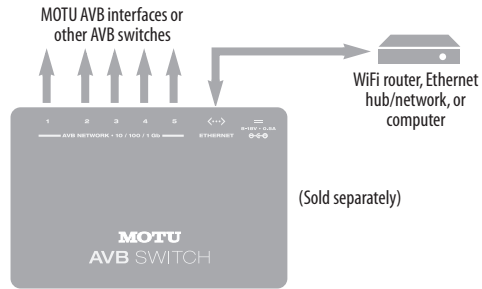

- Expand the network by adding more switches. Make a single connection from one switch to the other. On MOTU AVB Switches, use their AVB NETWORK ports, NOT the Ethernet port.
- You can daisy-chain switches in serial fashion, but don't create loops. For example, in the network below, do not make any additional connections between any two switches.

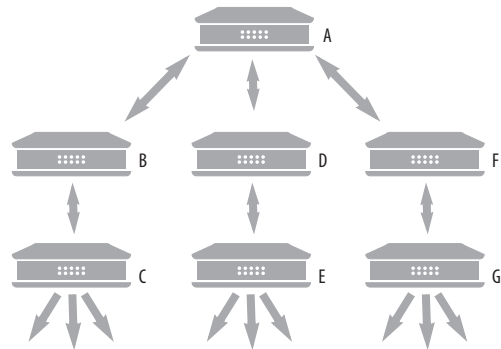

- AVB audio can't pass through more than seven switches. However, you can daisy-chain more than seven switches and route audio freely among them. You just won't be able to create point-to-point connects that span more than seven switches.

Working with computers on a network

- Computers are not required for network operation, as you can control the network from iPads, tablets and smart phones.

- To add computers to the network, connect them to any interface using Thunderbolt (which offers the highest possible channel counts). If Thunderbolt is not available, use USB.
- A computer can be connected to the network through its Ethernet port, but only for the purposes of running the web app on the computer for command and control over the network. (In this scenario, you won't be able to stream audio to/from the network from the computer.)
- All computers and interfaces on the network have full access to each other.
- MOTU employs a 1 Gbit AVB implementation in the MOTU AVB Switch. The switch allows routing of many audio channels on the network.

SETTING UP A MOTU AVB INTERFACE FOR NETWORKING

Depending on the model, MOTU AVB interfaces have the ability to broadcast up to sixteen 8-channel streams to the rest of the network. Conversely, it can “listen” to as many as sixteen 8-channel streams from anywhere else in the network. The specific number of streams supported depends on the model.

For each device on the network, set it up for network operation as follows:

- 1 In the MOTU AVB Control web app, choose the device (item #1 on page 14).
- 2 Go to the Device tab (item #5 on page 14), go to the *AVB Stream Setup* section (item #25 on page 15), and type in the number of 8-channel input and output streams you want for that device.
- 3 Go to the *AVB Stream Connections* section (item #9 on page 15), and choose the network stream you want the device to listen to for each bank.

- 4 Use the Routing tab to map specific I/O channels within each MOTU AVB interface to its network input and output streams, as explained in the next section.

MAPPING AUDIO TO NETWORK STREAMS

Once you've configured a device's AVB streams, as explained above, use the Routing tab (page 16) to map audio channels to network input and output streams.

Input streams (coming from the rest of the network) are listed across the top of the routing grid. Expand the stream and click on the grid to map incoming network channels to local destinations, including physical outputs on the device, computer channels (to a connected computer), or mixer channels.

Output streams being broadcast to the rest of the network are listed in rows along the left side of the grid. Expand each stream bank and map individual network output channels to local sources, such as physical inputs on the interface, channels coming from the computer, or channels coming from the device's mixer.

MAPPING COMPUTER CHANNELS TO NETWORK STREAMS

If a host computer is connected to an interface (through USB), mapping network input and output streams is accomplished as described in the previous two sections. Simply enable AVB streams as desired, and map them to computer channels in the Routing grid.

If, while mapping, you run out of computer channels, enable more in the *Computer Setup* section of the Device tab (item #21 on page 15). If the computer is connected with Thunderbolt, you can enable a maximum of 128 channels in and out. If the computer is connected with USB, performance will vary, depending on the sample rate and other factors.

BRIDGING TO ETHERNET

The Ethernet port on the MOTU AVB Switch allows you to connect standard network devices, such as:

- A WiFi router
- An Ethernet hub or switch connected to a local home, studio, or office network
- Any other standard networking device

THE MOTU AVB SWITCH

The heart of a MOTU AVB network is the MOTU AVB Switch (sold separately). For a brief overview of the switch and its features, visit:

www.motu.com/products/avb/avb-switch.

Part 3

Appendices

APPENDIX A Troubleshooting

Some or all of my MOTU interface inputs and outputs are not available in my host audio software.

Make sure that the inputs and outputs are enabled in the Device tab (“Device tab” on page 14) and routed to and from the computer in the Routing tab (“Routing tab” on page 16). For details, see “Making inputs and outputs available to your host software” on page 56.

I have absolutely no audio input or output happening to or from my interface. Why?

Make sure that the unit has a stable sample rate (the sample rate will flash if the clock hasn’t settled yet). Try setting the unit’s clock source to *Internal* if you can’t sync to any external clock sources. Check that audio is working with Internal sync, and if so, then work on establishing a stable external clock.

I can't hear computer audio output through my MOTU AVB interface.

In the Sound panel of System Preferences, your MOTU AVB interface should be selected as the output device. Almost all applications will use just the first two output channels, so make sure that *From Computer 1* and *From Computer 2* are routed to the physical outputs that you are listening to in the Routing tab (e.g. Phones 1-2 or Analog 1-2).

How do I monitor live inputs?

Please refer to the documentation for the audio application that you are using. If your application does not support input monitoring, you will need to use the mixer in your MOTU interface. Please see “Monitoring through your MOTU interface” on page 59.

How do I control monitoring latency?

See “Reducing monitoring latency” on page 59.

The Routing tab (page 16) doesn't display some of the inputs or outputs on my interface.

The Routing tab only displays input and output banks that are enabled in the Device tab (page 14), so be sure any banks you wish to work with are enabled there. However, to conserve DSP resources and help consolidate screen-space in the other tabs, it is efficient practice to disable unused input or output banks (optical banks, for example, when only working with analog banks).

I'm getting a "Could not enable this effect because DSP is overloaded" error. What should I do?

Disable other effects or reduce the number of mixer inputs to conserve DSP resources. If there are audio input and output banks on your interface that you are not using (such as the optical banks), disable them in the Device tab (page 14).

I accidentally deleted my factory presets. How do I restore them?

In the Device tab (page 14), click the *Restore Factory Presets* button to restore all factory presets.

How do I factory reset my device?

Push the SELECT knob/button to enter the main menu. Navigate to *Settings > Factory Default* and push the SELECT knob/button twice to reset.

I can't authenticate AudioDesk.

When authenticating AudioDesk, the OK button does not become active until you have entered in your name and a valid keycode. Your name must contain at least three characters, and you must enter the keycode exactly as it appears (on the jacket of your AudioDesk installer disc). If you continue to have difficulties, try repairing Mac OS X disk permissions using *Disk Utility*.

I hear clicks and pops under word clock sync.

Many problems result from incorrect word clocking. It is essential that all digital devices in the system be word locked. Consult “Synchronization” on page 40 for detailed information on how to word clock your gear. Whenever there is any unexpected noise or distortion, suspect incorrect word lock.

Clicks and pops due to hard drive problems...

If you have checked your clock settings and you are still getting clicks and pops in your audio, you may have a drive related problem. Set your Clock Source to *Internal* and try recording just using the analog inputs and outputs on your MOTU interface. If you encounter the same artifacts you may want try using another drive in your computer. Clicks and pops can also occur when the drive is severely fragmented or there are other drive-related issues.

Connecting or powering gear during operation...

It is not recommended that you connect/disconnect, or power on/off devices connected to your MOTU interface while recording or playing back audio. Doing so may cause a brief glitch in the audio.

CUSTOMER SUPPORT

We are happy to provide complimentary customer support to our registered users. If you haven't already done so, please take a moment to register online at MOTU.com, or fill out and mail the included registration card. Doing so entitles you to technical support and notices about new products and software updates.

TECHNICAL SUPPORT

If you are unable, with your dealer's help, to solve problems you encounter with your MOTU device, you may contact our technical support department in one of the following ways:

- Tech support hotline: (617) 576-3066 (Monday through Friday, 9 a.m. to 6 p.m. EST)
- Online support: www.motu.com/support

Please provide the following information to help us solve your problem as quickly as possible:

- The serial number of your MOTU device. This is printed on a label placed on the bottom of the rack unit. You must be able to supply this number to receive technical support.
- A brief explanation of the problem, including the exact sequence of actions which cause it, and the contents of any error messages which appear on the screen.
- The pages in the manual that refer to the features or operation of your MOTU AVB Device or AudioDesk with which you are having trouble.
- The version of your computer's operating system.

We're not able to solve every problem immediately, but a quick call to us may yield a suggestion for a problem which you might otherwise spend hours trying to track down.

If you have features or ideas you would like to see implemented, we'd like to hear from you. Please write to the Development Team, MOTU Inc., 1280 Massachusetts Avenue, Cambridge, MA 02138, or use our online suggestion box at www.motu.com/suggestions.

APPENDIX B Audio Specifications

24Ao

Line Out

Connector Type	Panasonic/Tascam format “DB-25” D-Sub	AES-59 pin-outs, 4-40 retaining screw
	Phoenix screw block	Pin-outs as indicated by connector labeling
Output Impedance	100 ohm	Per leg
Dynamic Range	123 dB	A-weighted
THD+N	-110 dB (0.0003%)	-1 dBFS, Unweighted, 1 kHz
Frequency Response	+0, -0.1 dB, 20 Hz/20 kHz	Ref. 1 kHz
Max Level Out	+20 dBu	
Trim Range	24 dB	-4 dBu to +20 dBu in 1 dB steps

Word Clock In/Out/Thru

Specification	AES-11 2009 Annex B	
Connector Type	BNC	
Termination	75 ohm (in/out)	THRU is unterminated
Lock Range	44.1 kHz / 48kHz, +/- 0.5%	x1/x2/x4
Input	1 vpp to 3 v p-p (with termination)	AC coupled
Output	5.0 vpp, (2.5 v p-p terminated)	DC coupled
Jitter	complies with AES3-4-2009	< 0.025 UI

Power Supply

Connector Type	IEC 3-conductor receptacle	For AC mains connection
Configuration	Internal, Universal	
Power Input	100 V to 240 V, 50 Hz or 60 Hz	
Power Usage	35 watts	

24Ai

Line In

Connector Type	Panasonic/Tascam format “DB-25” D-Sub	AES-59 pin-outs, 4-40 retaining screw
	Phoenix screw block	Pin-outs as indicated by connector labeling
Specification	Complies with EBU-R68 / SMPTE RP-155	
Impedance Load	10 k ohm	
Dynamic Range	110 dB	A-weighted
THD+N	-102 dB (0.0008%)	-1 dBFS, Unweighted
Frequency Response	+0, -0.1 dB, 20 Hz/20 kHz	Ref. 1 kHz
Max Level In	+24 dBu	
Trim Range	118 dB	-96 to +22 dB in 1 dB steps

Word Clock In/Out/Thru

Specification	AES-11 2009 Annex B	
Connector Type	BNC	
Termination	75 ohm (in/out)	THRU is unterminated
Lock Range	44.1 kHz / 48kHz, +- 0.5%	x1/x2/x4
Input	1 vpp to 3 v p-p (with termination)	AC coupled
Output	5.0 vpp, (2.5 v p-p terminated)	DC coupled
Jitter	complies with AES3-4-2009	< 0.025 UI

Power Supply

Connector Type	IEC 3-conductor receptacle	For AC mains connection
Configuration	Internal, Universal	
Power Input	100 V to 240 V, 50 Hz or 60 Hz	
Power Usage	35 watts	

APPENDIX C Mixer Schematics

MONO INPUT CHANNEL

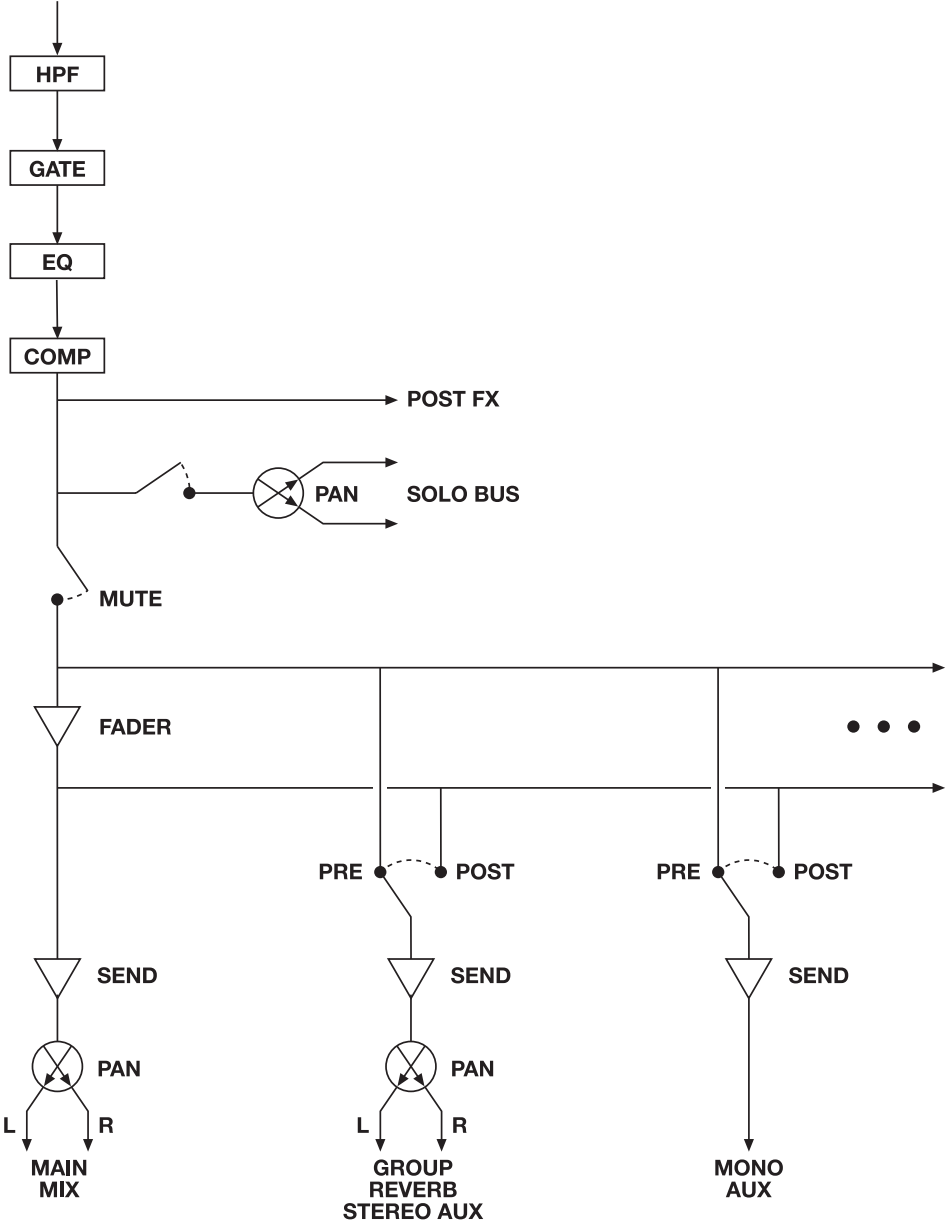

STEREO INPUT CHANNEL

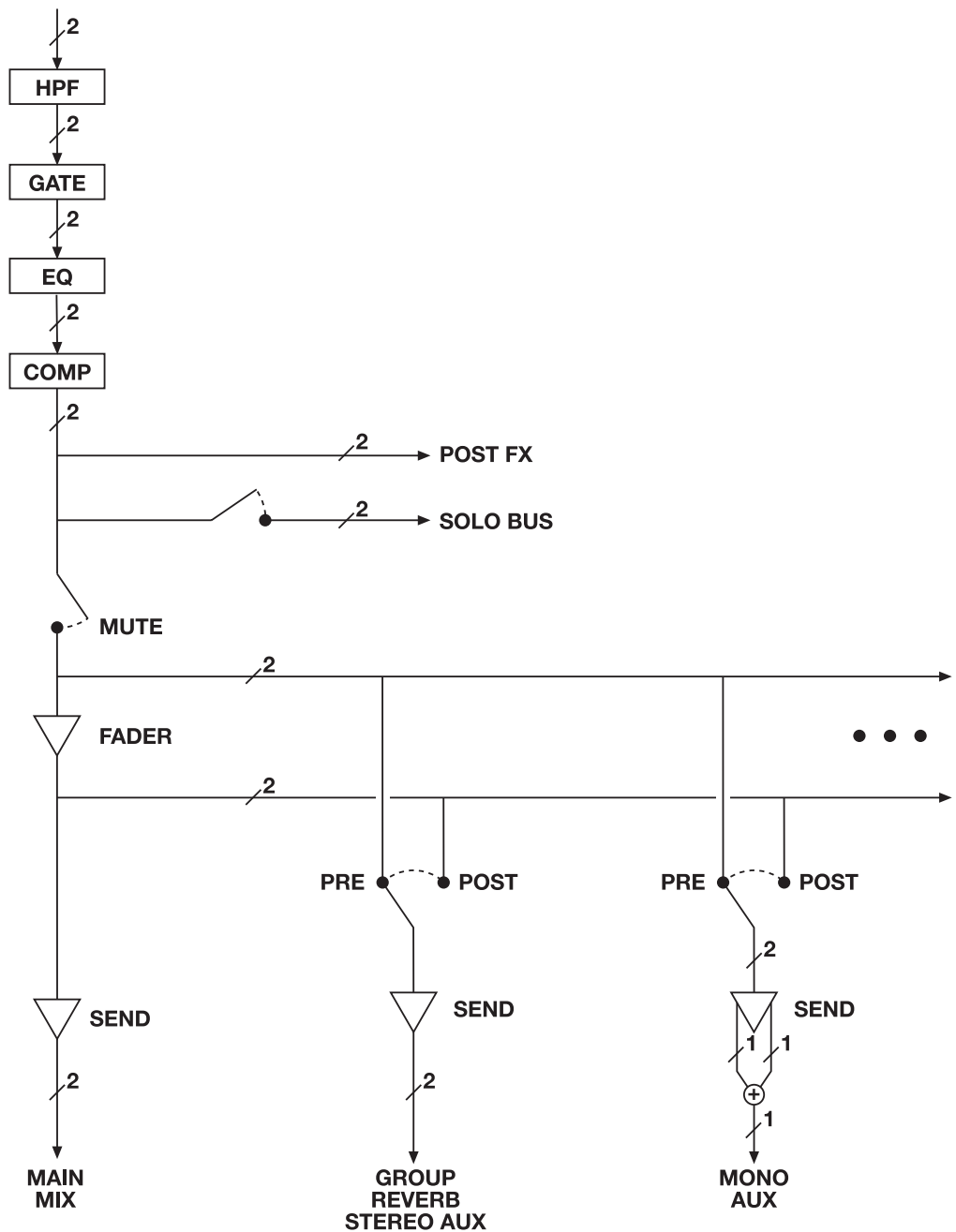

GROUP BUS

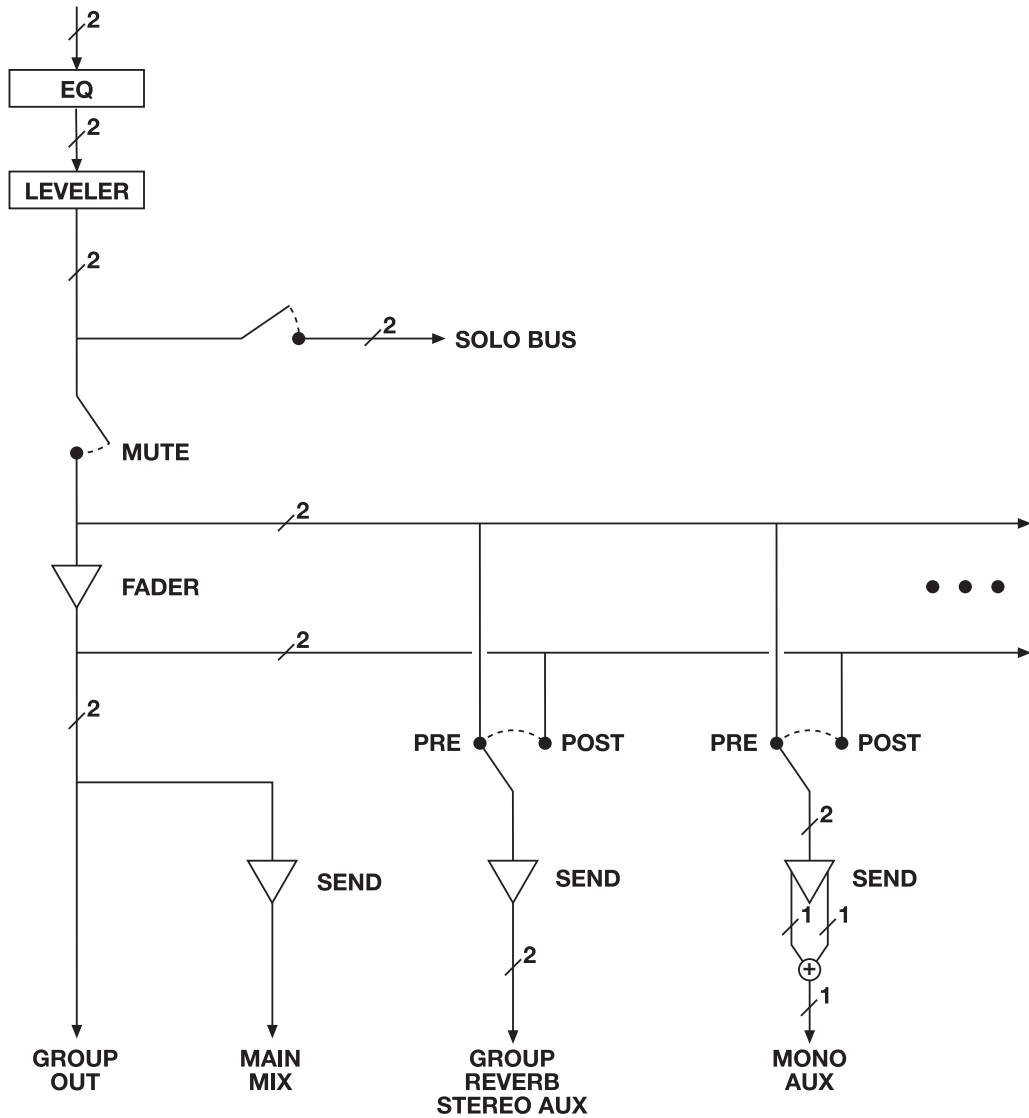

MONITOR BUS

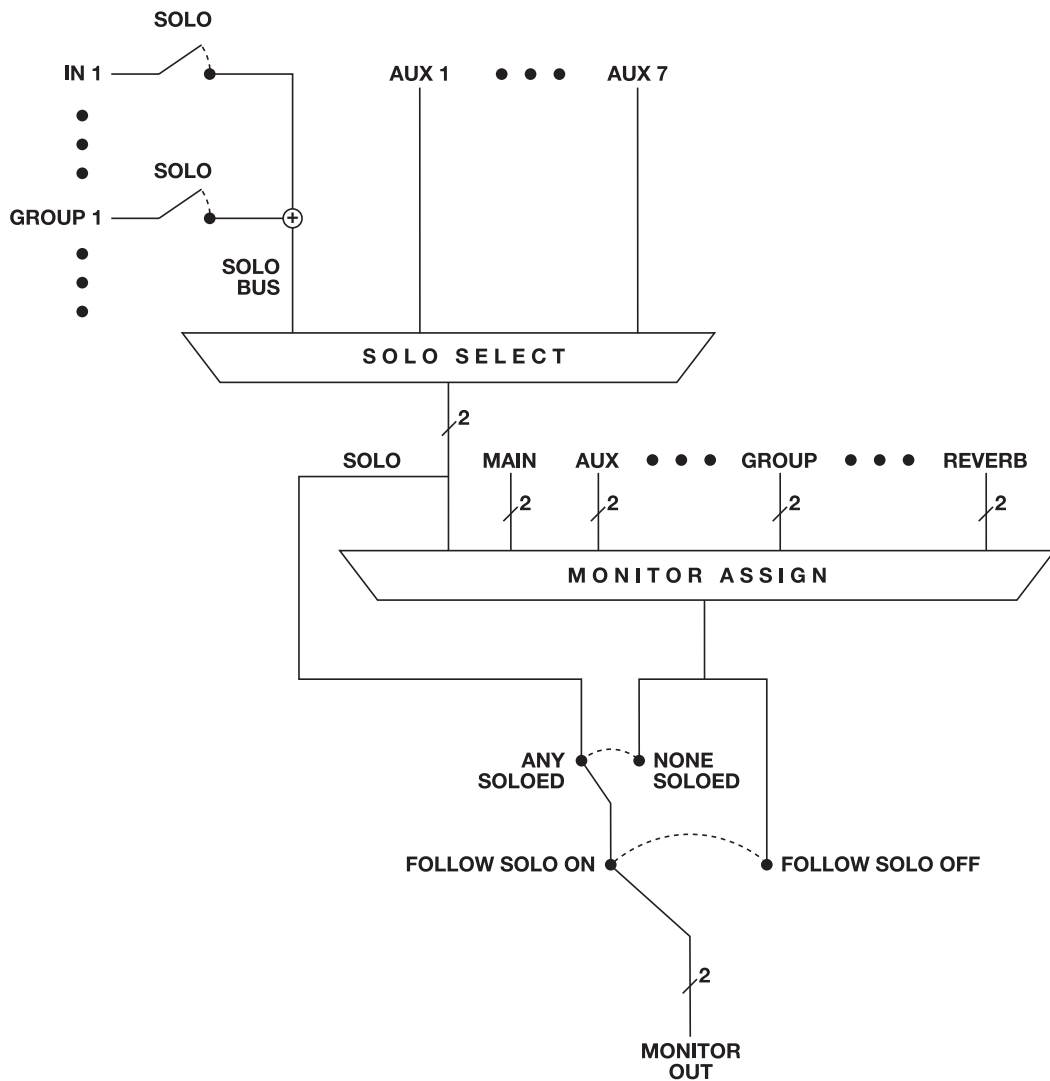

APPENDIX D D-sub Connector Specifications

D-SUB CABLE PIN-OUTS

The 24Ai and 24Ao follow the Panasonic/Tascam (AES-59) standard specification for a female D-sub connector with balanced analog input or output.

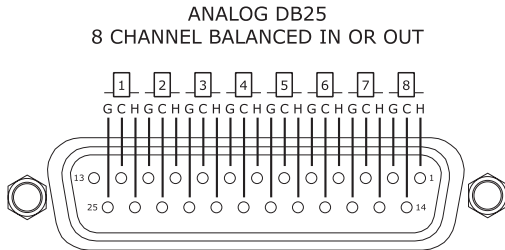

A NOTE ABOUT RETAINING SCREWS

The 24Ai and 24Ao D-sub connectors are equipped with standard nuts with a 4-40 thread size, which support 4-40 retaining screws. When you purchase your DB-25 cable, most DB-25 cables include 4-40 screws, *but they may not be installed on the cable yet*. Instead, the cable may have metric screws on it, with the 4-40 screws supplied separately (in a bag or pouch). If this is the case, remove the currently installed screws and replace them with the supplied 4-40 screws.

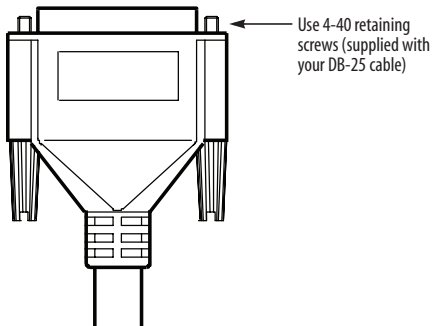

Pin	Signal
1	Channel 8 (+)
2	SG (Signal Ground)
3	Channel 7 (-)
4	Channel 6 (+)
5	SG
6	Channel 5 (-)
7	Channel 4 (+)
8	SG
9	Channel 3 (-)
10	Channel 2 (+)
11	SG
12	Channel 1 (-)
13	Not used
14	Channel 8 (-)
15	Channel 7 (+)
16	SG
17	Channel 6 (-)
18	Channel 5 (+)
19	SG
20	Channel 4 (-)
21	Channel 3 (+)
22	SG
23	Channel 2 (-)
24	Channel 1 (+)
25	SG

APPENDIX E **Updating Firmware**

MOTU periodically posts firmware updates for your MOTU AVB interface. These updates may include bug fixes, enhancements, and new features.

Updates are posted on MOTU's servers. If your computer or Wi-Fi device has access to the internet, the MOTU AVB Control app notifies you as soon as an update is made available. Otherwise, you can check motu.com/avb periodically for the latest firmware update.

A network cable connection is required

Firmware updating requires a network cable connection, so before you begin, connect a standard CAT-5 or CAT-6 network cable from the network port on your MOTU interface to one of the following:

- Your computer's network port (or a Thunderbolt-to-Ethernet adapter)
- Your home, studio, or office network (with internet access)
- An AVB port on a MOTU AVB switch (connected to your office network through the Ethernet port)

Updating with internet access

You are now ready to update:

- 1** Launch the MOTU AVB Control web app on your computer, iPad, or iPhone, as usual.
- 2** Go to the Device tab.
- 3** In the *New Update Available* banner (Figure E-1), click *More Info*.
- 4** After reviewing the list of enhancements, click OK to start the update.
- 5** Wait a few moments for the update to finish, then click OK to return to the Device tab.
- 6** **IMPORTANT:** disconnect the Ethernet cable from your MOTU interface after you complete the update, unless it is connected to a MOTU AVB switch or other AVB-aware switch. If so, you can leave it connected.

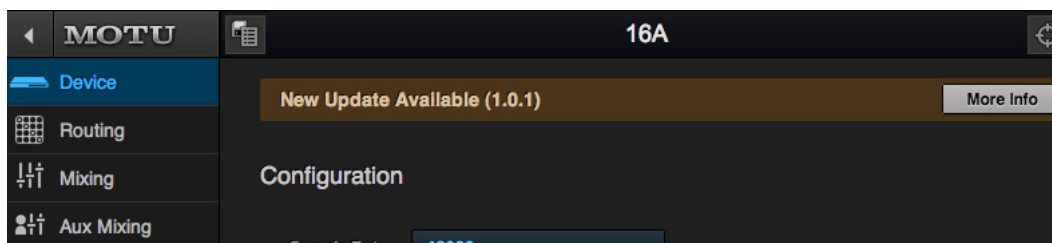

Figure E-1: The firmware update banner appears automatically at the top of the Device tab when your web host has internet access and MOTU posts an update.

Updating off-line, without internet access

If your MOTU AVB interface (and the computer it is connected to) has no internet access, you can download a firmware update file from another computer that does have internet, and then use the file to update your MOTU interface, as follows:

- 1 Download the firmware file.
- 2 Transfer the file to a computer with a network cable connection to your MOTU interface.
- 3 Launch the MOTU AVB Control web app on the computer, as usual.
- 4 Go to the Device tab.
- 5 Scroll down to the bottom and click *Update from File*.
- 6 Locate the file on your hard drive and click OK to start the update.
- 7 Wait a few moments for the update to finish, then click OK to return to the Device tab.
- 8 **IMPORTANT:** disconnect the Ethernet cable from your MOTU interface after you complete the update, unless it's connected to a MOTU AVB switch or other AVB-aware switch. If so, you can leave it connected.

Viewing the latest firmware version information

You can confirm the firmware version at the bottom of the Device tab (Figure E-2).

Why does the firmware update require a network cable?

Firmware updating was designed to use ethernet mostly for convenience. If you have lots of networked devices, you can upgrade them all from a distance (even over Wi-Fi) without having to plug in directly and without having to download or run an updater application.

This approach was also taken for engineering reasons, with reliability foremost in mind. When installing an update, the device reboots into a stripped-down recovery partition to guarantee that the update process can always be completed, even if the power goes out mid-update. Since updates can also affect the Thunderbolt or USB chips, they cannot be used during the update.

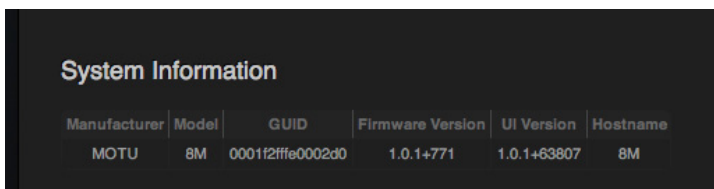

Manufacturer	Model	GUID	Firmware Version	UI Version	Hostname
MOTU	8M	0001f2ffe0002d0	1.0.1+771	1.0.1+63807	8M

Figure E-2: The currently installed firmware version is displayed at the bottom of the Device tab.

APPENDIX F **OSC Support**

Open Sound Control (OSC) is a protocol for communication among computers and other multimedia devices that is optimized for modern networking technology.

MOTU AVB audio interfaces support OSC, which provides remote control of all device settings and mixer controls from any OSC-enabled controller.

For further details about remote control through OSC, along with complete documentation for the MOTU AVB OSC API, visit:

<http://www.motu.com/avb#avb-osc-support>

24Ai
expansion 34
front panel 9
installing 33
rear panel 10
summary of features 23

24Ao
expansion 34
front panel 11
installing 33
rear panel 12
summary of features 23

24-bit
optical 10, 12
2x SMUX mode 15, 40

A

Ableton Live 55, 58
ADAT optical 10, 12
connecting 40
SMUX Type 54
Analog inputs/outputs 40
Apple

Garage Band 58
Logic Pro 58

ASIO Buffer Size 30
ASIO monitoring 59

Attack
Compressor 64, 65
Audio interface preset 7, 47
AudioDesk 25, 31, 55, 58
authenticating 77

Aux Mix Target 18
Aux Mixing tab 18

AVB
audio interface operation 24
Discovery app 7, 30
Ethernet explained 69
Input/Output Banks 15
networking 69-74
overview 69
Stream Connections 15
Stream Setup 15
streams (Routing tab) 16
Switch
setup 35, 39

AVB Control web app 7, 13-22
Aux Mixing tab 18
Device tab 14, 15
Mixing tab 17
Routing tab 16

Avid
Pro Tools 58

B

Become Clock Master 14, 42

C

CAT-5e/6 cables 34
Check for Updates 15
Chrome 13
Class compliance 29

Clock section (LCD) 54
Clock source 14, 40
Cockos Reaper 58
Compressor effect 17, 65
Computer Setup 15
Connecting multiple interfaces 34
Control Panel 30, 60
Control surface support (through OSC) 89
Converter mode
setup/example 51
Core Audio driver 58
Cubase 55, 58
clock source 55
sample rate 55
Customer
support 78

D

Device tab 14, 15
Digital converter (see Optical converter)
Digital Performer 55, 58
Direct hardware playthrough 59
Direct ASIO monitoring 59
Direct hardware playthrough 59
Driver installation 7, 13, 29
Drivers
installing USB drivers 30

DSP
effects 63
meter 68
resources 68
DSP Usage 19, 68

E

Effects 63
EQ 64
enabling 64
filter types 64
frequency 64
gain 64
Q 64
Ethernet
connecting 39
Expansion 34

F

Firefox 13
Firmware updates 14
Follow Solo 17, 20
Force 1x Clock setting 42
Four-band EQ 64
Frequency
EQ 64
From Computer 16
Front panel 53
menu navigation 53
metering 53

G

Gain
EQ 64
reduction 65
reduction (Leveler) 67
Garage Band 55, 58

clock source 55
sample rate 55

Gate effect 17, 64
GR (gain reduction) 65

H

High pass filter 63
Host audio software
3rd party software sync 61

I

ID knob/button 13, 14, 53
IEEE 802.1 69
Input banks 15
Input settings 14
Inputs
optical 10, 12
Installation
AVB audio interface 34
hardware 33
network 35, 36
QuickStart Guide 7
software 30
Thunderbolt interface 33
two interfaces networked 34
Interface + mixer preset 7, 48
Internet Explorer 13
IP address 13
iPad
QuickStart 7

L

Latency 59, 61
LCD
menu 53
Leveler 17, 66
Lightpipe 40
2x mode 54
Limit button 67
Live 58
Live recording with monitor mixing preset
7, 49
Logic Pro 58
Logic Pro/Express 55
clock source 55
sample rate 55

M

Mac OS X 55
input and output names 57
system requirements 27
Makeup gain 67
Mixer
accessing 17
aux bus 21
effects 63
group bus 22
input channel strip 19
main mix channel strip 20
Monitor channel strip 20
overview 17
Reverb bus 22
schematics 81
Setup 15

- stand-alone operation 63
- Mixing tab 17
- MOTU
 - AudioDesk 58
 - AVB Control web app 7, 13-22
 - Aux Mixing tab 18
 - Device tab 14, 15
 - Mixing tab 17
 - Routing tab 16
 - AVB Discovery app 7, 30
 - AVB Installer 7, 29
 - AVB Switch
 - setup 35, 39
 - Digital Performer 58
- MOTU AVB
 - Control web app 13
 - Discovery app 13
 - Installer 13
 - USB ASIO driver 58
 - WebUI Setup 13
- MOTU AVB WebUI Setup 30

N

- Networking 69-74
 - installation 35, 36
- Nuendo 55, 58
 - clock source 55
 - sample rate 55

O

- Optical
 - 2x mode 54
 - connectors 10, 12, 40
 - S/PDIF 40
- Optical converter mode 54
 - setup/example 51
- Optical Converter preset 7, 51
- Optical setup 15
- Optimization 61
- OS X audio software
 - clock source 55
 - sample rate 55
- OSC support 89
- Output banks 15
- Outputs
 - optical 10, 12

P

- Packing list 27
- Patch thru
 - latency 61
- Performance 61

- Phase-lock 41
- PRE switch 17
- PreDelay 67
- Prefader button 18
- Presets 7, 14
 - Mixer tab 17
 - overview 47
 - Routing tab 16
- Pro Tools 55, 58
- Processing 63

Q

- Q 64
- Quick Setup window 7
- QuickStart Guide 7

R

- Ratio
 - Compressor 65
- Reaper 55, 58
- Reason 55
 - Propellerhead Reason 58
- Record 55
- Registration 27
- Release
 - Compressor 64, 65
- Remote control (through OSC) 89
- Restore Factory Presets 15
- Reverb 67-68
 - design section 67
 - enabling/disabling 67
 - predelay 67
 - routing to/from 67
 - time 67, 68
 - width 68
- RMS mode 65
- Routing tab 16

S

- S/MUX 54
- S/PDIF (optical) 40
- Safari 13
- Sample rate 14
- SC button 20
- Schematics 81
- SMUX 40
- Software
 - installation 30
- Software installer 7, 13, 29
- Solo bus 20
- Solo Clear button 19
- SONAR 55

- Soundtrack Pro
 - clock source 55
 - sample rate 55
- Stage I/O preset 7, 49
- Stand-alone mixer preset 7, 48
- Stand-alone operation 53, 54
- Standard (optical setting) 40
- Steinberg
 - Cubase 58
 - Nuendo 58
- Studio Input Expander preset 7, 50
- Studio Output Expander preset 7, 50
- Synchronization 40
 - Become Clock Master 42
 - host software 61
- System requirements
 - minimum 27
 - recommended computer 27

T

- Technical support 78
- Threshold
 - Compressor 65
- To Computer 16
- TOSLink 40
- Troubleshooting 77
- TRS analog inputs/outputs 40
- Type I, II optical mode 54
- Type II (Legacy) optical setting 40

U

- Update From File 15
- USB
 - class compliance 29
 - installing drivers 30
- USB Streaming Mode 30

V

- View Personal Mix 18

W

- Wave driver 58
- Width
 - reverb 68
- WiFi
 - setup 39
- Windows
 - shortcut 30
 - system requirements 27
- Word clock
 - Force 1x Clock setting 42